

Introduction to CATIA V5

Release 17

(A Hands-On Tutorial Approach)

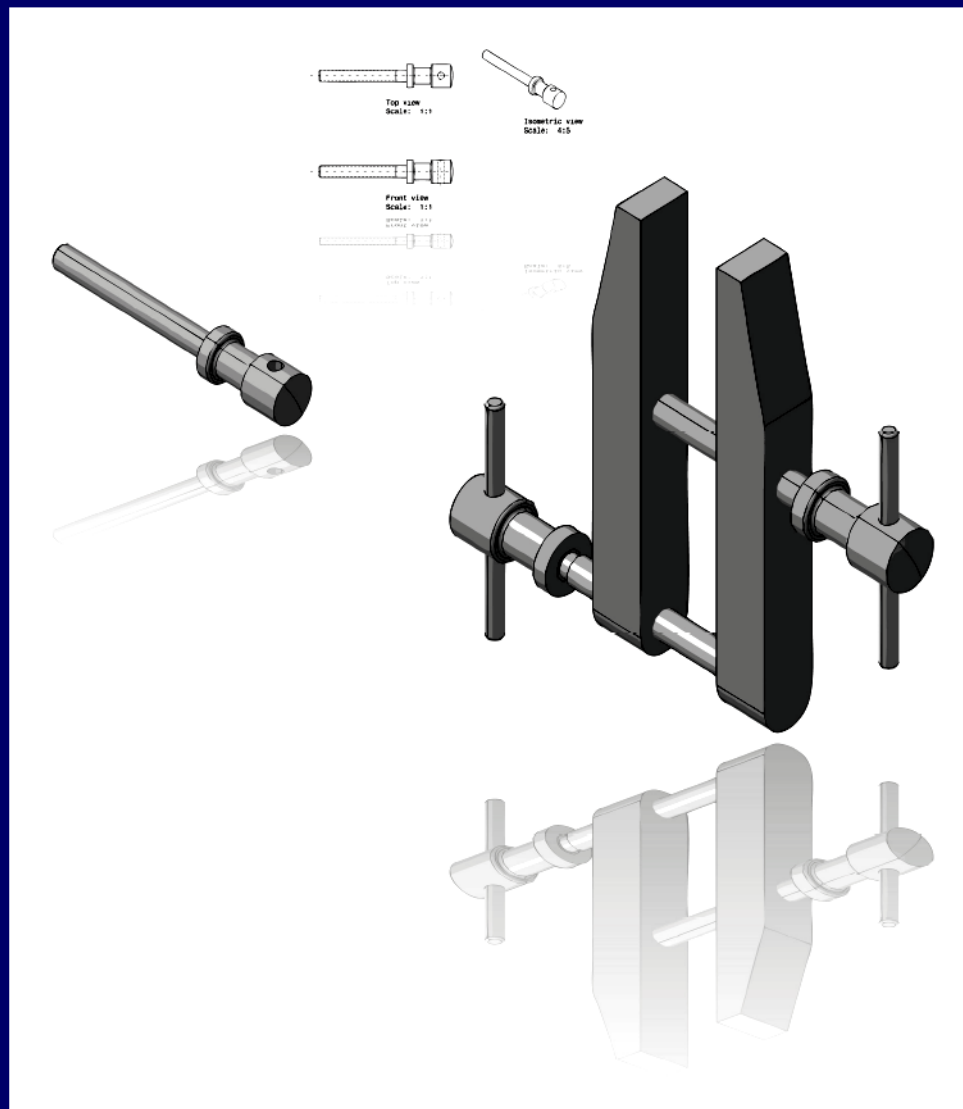

Kirstie Plantenberg
University of Detroit Mercy

SDC
PUBLICATIONS

Schroff Development Corporation
www.schroff.com

Better Textbooks. Lower Prices.

TABLE OF CONTENTS

Chapter 1: CATIA Basics

- Chapter 1 Introduction 1-1
- Tutorial 1.1: CATIA's interface and file management 1.2-1
- Tutorial 1.2: Selecting, Editing & Viewing Objects 1.2-1

Chapter 2: Sketcher

- Chapter 2 Introduction 2-1
- Tutorial 2.1: Sketch Work Modes 2.1-1
- Tutorial 2.2: Simple Profiles & Constraints 2.2-1
- Tutorial 2.3: Advanced Profiles & Sketch Analysis 2.3-1
- Tutorial 2.4: Modifying Geometries & Relimitations 2.4-1
- Tutorial 2.5: Axes & Transformations 2.5-1
- Tutorial 2.6: Operations on 3D Geometries & Sketch planes 2.6-1
- Tutorial 2.7: Points & Splines 2.7-1
- Exercises 2.8-1

Chapter 3: Part Design

- Chapter 3 Introduction 3-1
- Tutorial 3.1: Sketch-Based Features: Pads 3.1-1
- Tutorial 3.2: Sketch-Based Features: Pockets, Holes & Slots 3.2-1
- Tutorial 3.3: Sketch-Based Features: Shafts & Grooves 3.3-1
- Tutorial 3.4: Sketch-Based Features: Advanced commands 3.4-1
- Tutorial 3.5: Dress-Up Features: Drafts, Fillets & Chamfers 3.5-1
- Tutorial 3.6: Dress-Up Features: Shell, Thickness & Threads 3.6-1
- Tutorial 3.7: Transformation Features 3.7-1
- Tutorial 3.8: Boolean Operations 3.8-1
- Tutorial 3.9: Material Properties 3.9-1
- Exercises 3.10-1

Chapter 4: Wireframe and Surface Design Fundamentals

- Chapter 4 Introduction 4-1
- Tutorial 4.1: Wireframe toolbar 4.1-1
- Tutorial 4.2: Surfaces toolbar 4.2-1
- Tutorial 4.3: Operations toolbar 4.3-1
- Exercises 4.4-1

Chapter 5: Assembly Design Fundamentals

- Chapter 5 Introduction 5-1
- Tutorial 5.1: Assembly Constraints and Advanced Commands 5.1-1
- Tutorial 5.2: Advanced Assembly 5.2-1
- Exercises 5.3-1

Chapter 6: Drafting Fundamentals

- Chapter 6 Introduction 6-1
- Tutorial 6.1: Generative Drafting 6.1-1
- Exercises 6.2-1