

Engineering Design with SolidWorks® 2014 and Video Instruction

A Step-by-Step Project Based Approach
Utilizing 3D Solid Modeling

Videos
Contains all new training
videos for SolidWorks 2014

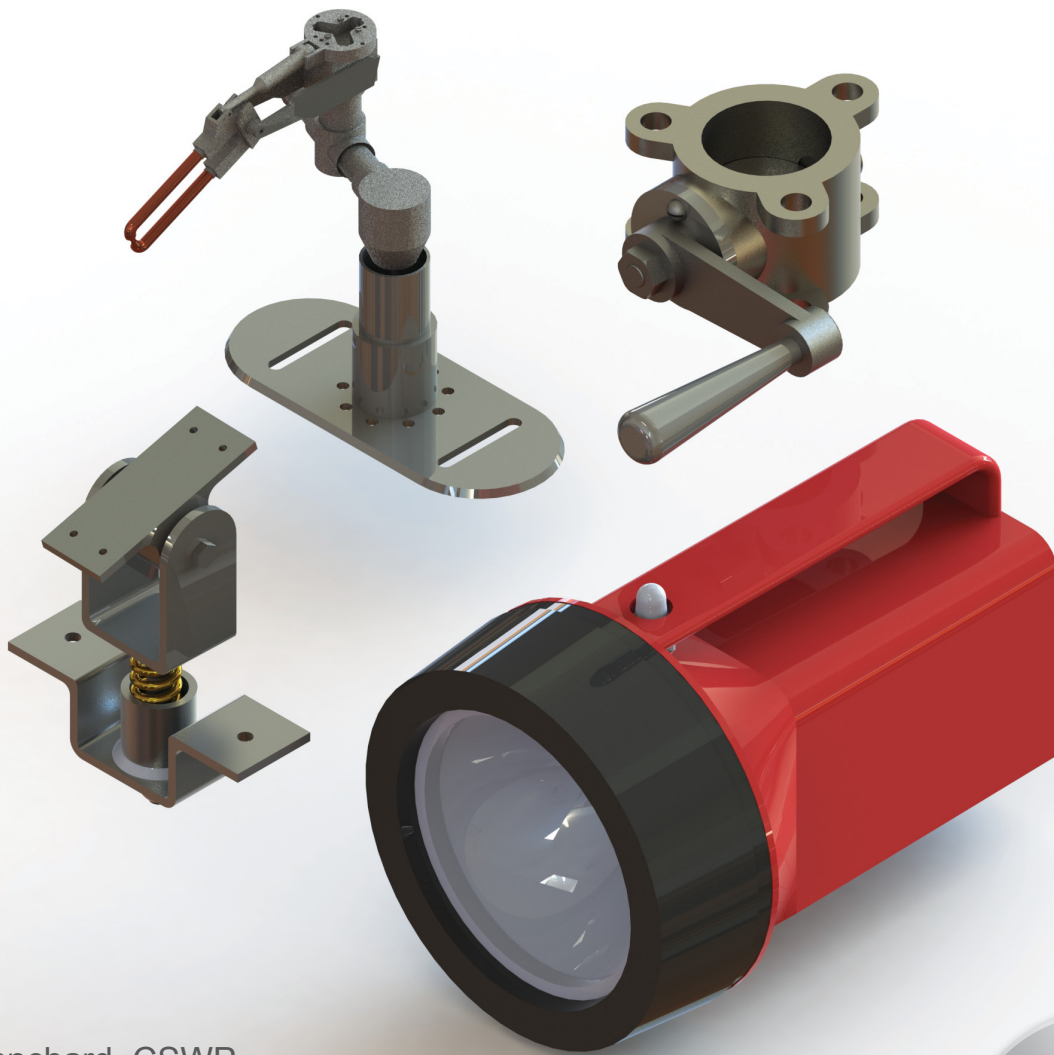

David C. Planchard, CSWP,
SolidWorks Accredited Educator



Better Textbooks. Lower Prices.
www.SDCpublications.com



Visit the following websites to learn more about this book:



[amazon.com](https://www.amazon.com)

[Google books](https://books.google.com)

[BARNES & NOBLE](https://www.barnesandnoble.com)

Table of Contents

| | |
|---|------------|
| Introduction | I-1 |
| About the Author | I-2 |
| Acknowledgements | I-3 |
| Contact the Author | I-3 |
| Note to Instructors | I-3 |
| Trademarks, Disclaimer and Copyrighted Material | I-3 |
| References | I-4 |
| Table of Contents | I-6 |
| Overview of Projects | I-14 |
| What is SolidWorks? | I-19 |
| About the Book | I-21 |
| Windows Terminology in SolidWorks | I-22 |
| | |
| Project 1 - Fundamentals of Part Modeling | 1-1 |
| Project Objective | 1-3 |
| Project Situation | 1-4 |
| Project Overview | 1-6 |
| File Management | 1-7 |
| Start a SolidWorks 2014 Session | 1-9 |
| Understand the SolidWorks User Interface and CommandManager | 1-10 |
| Menu bar toolbar | 1-10 |
| Menu bar menu | 1-10 |
| Drop-down menu | 1-11 |
| Right-click | 1-11 |
| Consolidated toolbar | 1-12 |
| System feedback icons | 1-12 |
| Confirmation Corner | 1-12 |
| Heads-up View toolbar | 1-13 |
| SolidWorks CommandManager | 1-16 |
| FeatureManager Design Tree | 1-20 |
| Fly-out FeatureManager | 1-22 |
| Task Pane | 1-23 |
| SolidWorks Forum | 1-23 |
| Design Library | 1-24 |
| File Explore | 1-25 |
| Search | 1-25 |
| View Palette | 1-25 |
| Appearances, Scenes, and Decals | 1-26 |
| Custom Properties | 1-26 |
| Document Recovery | 1-26 |
| Motion Study tab | 1-27 |
| MotionManager | 1-27 |
| Animation | 1-27 |
| Basic Motion | 1-27 |
| System Options | 1-33 |
| Part Document Template and Document Properties | 1-34 |
| PLATE Part Overview | 1-37 |
| PLATE Part-New SolidWorks Document | 1-39 |

| | |
|--|------------|
| PLATE Base Feature | 1-40 |
| Machined Part | 1-41 |
| Reference Planes and Orthographic Projection | 1-42 |
| PLATE Part-Extruded Boss/Base Feature | 1-46 |
| PLATE Part-Modify Dimensions and Rename | 1-55 |
| Display Modes, View Modes, View tools, and Appearances | 1-57 |
| Fasteners | 1-59 |
| PLATE Part-Extruded Cut Feature | 1-60 |
| PLATE Part-Fillet Feature | 1-66 |
| PLATE Part-Hole Wizard | 1-68 |
| ROD Part Overview | 1-71 |
| ROD Part-Extruded Boss/Base Feature | 1-73 |
| ROD Part-Hole Wizard Feature | 1-75 |
| ROD Part-Chamfer Feature | 1-76 |
| ROD Part-Extruded Cut Feature & Convert Entities Sketch Tool | 1-77 |
| ROD Part-View Orientation, Named Views & Viewport option | 1-82 |
| ROD Part-Copy/Paste Function | 1-83 |
| ROD Part-Design Changes with Rollback Bar | 1-84 |
| ROD Part-Recover from Rebuild Errors | 1-86 |
| ROD Part-Edit Part Color | 1-90 |
| GUIDE Part Overview | 1-92 |
| GUIDE Part-Extruded Boss/Base Feature and Dynamic Mirror Feature | 1-94 |
| GUIDE Part-Extruded Cut Slot Profile | 1-97 |
| GUIDE Part-Mirror Feature | 1-101 |
| GUIDE Part-Holes | 1-102 |
| GUIDE PART-Linear Pattern Feature | 1-105 |
| GUIDE Part-Materials Editor and Mass Properties | 1-107 |
| Manufacturing Considerations | 1-109 |
| Sketch Entities and Sketch Tools | 1-112 |
| Project Summary | 1-113 |
| Project Terminology | 1-117 |
| Questions / Exercises | 1-120 |
| | |
| Project 2 - Fundamentals of Assembly Modeling | 2-1 |
| Project Objective | 2-3 |
| Project Situation | 2-4 |
| Project Overview | 2-5 |
| Bottom-up Assembly Modeling Approach | 2-5 |
| Linear Motion and Rotational Motion | 2-6 |
| GUIDE-ROD assembly | 2-7 |
| GUIDE-ROD assembly - Insert Components | 2-11 |
| FeatureManager Syntax | 2-13 |
| Mate Types | 2-16 |
| Standard Mates | 2-16 |
| Advanced Mates | 2-17 |
| Mechanical Mates | 2-18 |
| Quick Mate | 2-18 |
| GUIDE-ROD Assembly - Mate the ROD Component | 2-20 |
| GUIDE-ROD Assembly - Mate the PLATE Component | 2-23 |
| GUIDE-ROD Assembly - Mate Errors | 2-27 |
| Collision Detection | 2-30 |

| | |
|---|------|
| Modify Component Dimension | 2-31 |
| SolidWorks Design Library | 2-32 |
| GUIDE-ROD Assembly - Inert Mates for Flange bolts | 2-35 |
| Socket Head Cap Screw Part | 2-39 |
| SmartMates | 2-45 |
| Coincident/Concentric SmartMate | 2-46 |
| Tolerance and Fit | 2-48 |
| Exploded View | 2-52 |
| Section View | 2-57 |
| Analyze an Interference Problem | 2-59 |
| Save As Copy Option | 2-60 |
| Save as | 2-60 |
| Save as copy and continue | 2-60 |
| Save as copy and open | 2-60 |
| GUIDE-ROD Assembly-Pattern Driven Component Pattern | 2-63 |
| Redefining Mates and Linear Components Pattern | 2-65 |
| Folders and Suppressed Components | 2-67 |
| Make-Buy Decision-3D ContentCentral | 2-68 |
| CUSTOMER Assembly | 2-70 |
| Copy the CUSTOMER Assembly - Pack and Go | 2-76 |
| Point at the Center of Mass | 2-78 |
| Project Summary | 2-80 |
| Project Terminology | 2-81 |
| Questions / Exercises | 2-88 |

Project 3 - Fundamentals of Drawing

3-1

| | |
|--|------|
| Project Objective | 3-3 |
| Project Situation | 3-4 |
| Project Overview | 3-4 |
| Drawing Template and Sheet Format | 3-5 |
| Sheet Format and Title Block | 3-12 |
| Company Logo | 3-17 |
| Save Sheet Format and Save As Drawing Template | 3-18 |
| GUIDE Part - Modify | 3-22 |
| GUIDE Part - Drawing | 3-23 |
| Move Views and Properties of the Sheet | 3-26 |
| Auxiliary View, Section View and Detail View | 3-29 |
| Auxiliary View | 3-30 |
| Section View | 3-31 |
| Detail View | 3-32 |
| Partial Auxiliary View - Crop View | 3-33 |
| Display Modes and Performance | 3-35 |
| Detail Drawing | 3-37 |
| Move Dimensions in the Same View | 3-40 |
| Partial Auxiliary View-Crop View | 3-40 |
| Move Dimensions to a Different View | 3-44 |
| Dimension Holes and the Hole Callout | 3-45 |
| Center Marks and Centerlines | 3-48 |
| Modify the Dimension Scheme | 3-50 |
| GUIDE Part-Insert an Additional Feature | 3-54 |
| General Notes and Parametric Notes | 3-56 |

| | |
|---|------------|
| Revision Table | 3-59 |
| Part Number and Document Properties | 3-61 |
| Exploded View | 3-67 |
| Balloons | 3-69 |
| Bill of Materials | 3-71 |
| Insert a Center of Mass Point into a drawing | 3-76 |
| Project Summary | 3-78 |
| Project Terminology | 3-78 |
| Questions / Exercises | 3-82 |
| Project 4 - Extrude and Revolve Features | 4-1 |
| Project Objective | 4-3 |
| Project Overview | 4-4 |
| Design Intent | 4-6 |
| Project Situation | 4-9 |
| Part Template | 4-11 |
| BATTERY Part | 4-15 |
| BATTERY Part - Extruded Boss/Base Feature | 4-17 |
| BATTERY Part - Fillet Feature Edge | 4-21 |
| BATTERY Part - Extruded Cut Feature | 4-23 |
| BATTERY Part - Fillet Feature Face | 4-25 |
| BATTERY Part - Extruded Boss/Boss Feature | 4-26 |
| Injection Molded Process | 4-32 |
| BATTERYPLATE Part | 4-33 |
| Save As, Delete, Modify and Edit Feature | 4-34 |
| BATTERYPLATE Part - Extruded Boss/Base Feature | 4-36 |
| BATTERYPLATE Part - Fillet Features: Full Round, options | 4-37 |
| Multi-body Parts and the Extruded Boss/Base Feature | 4-40 |
| LENS Part | 4-42 |
| LENS Part-Revolved Base Feature | 4-43 |
| LENS Part-Shell Feature | 4-46 |
| Extruded Boss Feature and Convert Entities Sketch tool | 4-47 |
| LENS Part-Hole Wizard | 4-48 |
| LENS Part - Revolved Boss Thin Feature | 4-51 |
| LENS Part - Extruded Boss/Boss Feature and Offset Entities | 4-53 |
| LENS Part - Extruded Boss/Boss Feature and Transparent Optical Property | 4-55 |
| BULB Part | 4-56 |
| BULB Part - Revolved Base Feature | 4-57 |
| BULB Part - Revolved Boss Feature and Spline Sketch tool | 4-60 |
| BULB Part - Revolved Cut Thin Feature | 4-62 |
| BULB Part - Dome Feature | 4-63 |
| BULB Part - Circular Pattern Feature | 4-64 |
| Customizing Toolbars and Short Cut Keys | 4-68 |
| Design Checklist and Goals before Plastic Manufacturing | 4-70 |
| Mold Base | 4-72 |
| Applying SolidWorks Features for Mold Tooling Design | 4-72 |
| Manufacturing Design Issues | 4-82 |
| Project Summary | 4-83 |
| Project Terminology | 4-84 |
| Questions / Exercises | 4-88 |

| | |
|---|------------|
| Project 5 - Swept, Lofted and Additional Features | 5-1 |
| Project Objective | 5-3 |
| Project Overview | 5-4 |
| Project Situation | 5-5 |
| O-RING Part - Swept Base Feature | 5-7 |
| O-RING Part - Design Table | 5-9 |
| SWITCH Part - Lofted Base Feature | 5-13 |
| SWITCH Part - Dome Feature | 5-18 |
| Four Major Categories of Solid Features | 5-20 |
| LENSCAP Part | 5-20 |
| LENSCAP Part - Extruded Boss/Base, Extruded Cut and Shell Features | 5-21 |
| LENSCAP Part - Revolved Cut Thin Feature | 5-24 |
| LENSCAP Part - Thread, Swept Feature and Helix/Spiral Curve | 5-25 |
| HOUSING Part | 5-31 |
| HOUSING Part - Lofted Boss Feature | 5-34 |
| HOUSING Part - Second Extruded Boss/Base Feature | 5-38 |
| HOUSING Part - Shell Feature | 5-39 |
| HOUSING Part - Third Extruded Boss/Base Feature | 5-40 |
| HOUSING Part - Draft Feature | 5-41 |
| HOUSING Part - Thread with Swept Feature | 5-43 |
| HOUSING Part - Handle with Swept Feature | 5-48 |
| HOUSING Part - Extruded Cut Feature with Up To Surface | 5-53 |
| HOUSING Part - First Rib and Linear Pattern Feature | 5-55 |
| HOUSING Part - Second Rib Feature | 5-58 |
| HOUSING Part - Mirror Feature | 5-61 |
| FLASHLIGHT Assembly | 5-64 |
| Assembly Template | 5-65 |
| LENSANDBULB Sub-assembly | 5-65 |
| BATTERYANDPLATE Sub-assembly | 5-70 |
| CAPANDLENS Sub-assembly | 5-72 |
| FLASHLIGHT Assembly | 5-76 |
| Addressing Interference Issues | 5-82 |
| Export Files and eDrawings | 5-83 |
| Project Summary | 5-86 |
| Project Terminology | 5-86 |
| Questions / Exercises | 5-89 |
| | |
| Project 6 - Top-Down Assembly Modeling and Sheet Metal Parts | 6-1 |
| Project Objective | 6-3 |
| Project Situation | 6-4 |
| Top-Down Assembly Modeling | 6-5 |
| BOX Assembly Overview | 6-8 |
| InPlace Mates and In-Context features | 6-10 |
| Part Template and Assembly Template | 6-12 |
| Box Assembly and Layout Sketch | 6-13 |
| Global Values and Equations | 6-17 |
| MOTHERBOARD - Insert Component | 6-22 |
| POWERSUPPLY - Insert Component | 6-28 |
| Sheet Metal Overview | 6-34 |
| Bends | 6-34 |

| | |
|---|------------|
| Relief | 6-37 |
| CABINET - Insert Component | 6-37 |
| CABINET - Rip Feature and Sheet Metal Bends | 6-40 |
| CABINET - Edge Flange | 6-42 |
| CABINET - Hole Wizard and Linear Pattern | 6-45 |
| CABINET - Sheetmetal Library Feature | 6-49 |
| CABINET - Louver Forming tool | 6-53 |
| Manufacturing Considerations | 6-54 |
| Additional Pattern Options | 6-60 |
| CABINET - Formed and Flat States | 6-62 |
| CABINET - Sheet Metal Drawing with Configurations | 6-64 |
| PEM Fasteners and IGES Components | 6-70 |
| Derived Component Pattern | 6-74 |
| MOTHERBOARD - Assembly Hole Feature | 6-76 |
| Assembly FeatureManager and External References | 6-77 |
| Replace Components | 6-79 |
| Equations | 6-82 |
| Design Tables | 6-86 |
| BRACKET Part - Sheet Metal Features | 6-89 |
| BRACKET Part - In-Content Features | 6-91 |
| BRACKET Part - Edge, Tab, Break Corner and Miter Features | 6-93 |
| BRACKET Part - Mirror Component | 6-98 |
| MirrorBRACKET Part - Bends, Fold, Unfold and Jog Features | 6-101 |
| Project Summary | 6-106 |
| Project Terminology | 6-107 |
| Questions / Exercises | 6-109 |
| Project 7 - SimulationXpress, Sustainability and DFMXpress | 7-1 |
| Project Objective | 7-3 |
| SolidWorks SimulationXpress | 7-3 |
| SolidWorks SimulationXpress Wizard | 7-7 |
| Welcome | 7-7 |
| Fixtures | 7-7 |
| Loads | 7-8 |
| Materials | 7-8 |
| Run | 7-8 |
| Results | 7-8 |
| Optimize | 7-8 |
| Analyze the MGPMRod Part | 7-9 |
| Review of SolidWorks SimulationXpress | 7-12 |
| SolidWorks Sustainability | 7-13 |
| Life Cycle Assessment | 7-14 |
| Key Elements | 7-15 |
| Carbon Footprint | 7-15 |
| Energy Consumption | 7-15 |
| Air Acidification | 7-16 |
| Water Eutrophication | 7-16 |
| References | 7-17 |
| Methodology | 7-17 |
| SustainabilityXpress Wizard | 7-18 |
| Material Class | 7-18 |









































| | |
|--|------------|
| Material Name | 7-18 |
| Manufacturing Process | 7-18 |
| Generate a Report | 7-24 |
| SolidWorks DFMXpress | 7-25 |
| DFMXpress Wizard | 7-25 |
| Run | 7-26 |
| Settings | 7-26 |
| Close | 7-26 |
| Help | 7-26 |
| Project Summary | 7-27 |
| Questions / Exercises | 7-27 |
| | |
| Project 8 - Intelligent Modeling Techniques | 8-1 |
| Project Objective | 8-3 |
| Design Intent | 8-4 |
| Sketch | 8-4 |
| Geometric relations | 8-4 |
| Full Defined Sketch tool | 8-5 |
| SketchXpert | 8-8 |
| Equations | 8-11 |
| Dimension driven equations | 8-11 |
| Equation Driven Curve | 8-14 |
| Explicit Driven Equation Curve | 8-14 |
| Parametric Driven Equation Curve | 8-16 |
| Curves | 8-18 |
| Curve Through XYZ Points | 8-19 |
| Projected Composite Curves | 8-21 |
| Feature - End Conditions | 8-23 |
| Along A Vector | 8-26 |
| FeatureXpert (Constant Radius) | 8-27 |
| Symmetry | 8-28 |
| Bodies to mirror | 8-28 |
| Planes | 8-30 |
| Conic Sections | 8-31 |
| Assembly | 8-32 |
| Assembly Visualization | 8-32 |
| SolidWorks Sustainability | 8-33 |
| MateXpert | 8-34 |
| Drawing | 8-34 |
| DimXpert | 8-34 |
| Project Summary | 8-38 |
| Project Terminology | 8-38 |
| | |
| Appendix | A-1 |
| ECO Form | A-1 |
| Types of Decimal Dimensions (ASME Y14.5 2009) | A-1 |
| SolidWorks Keyboard Shortcuts | A-3 |
| Windows Shortcuts | A-3 |
| CSWA Certification | A-5 |
| Sustainable Design Associate (CSDA) Certification | A-5 |

| | |
|--|-----|
| Simulation Associate Finite Element Analysis (CSWSA-FEA) Certification | A-6 |
| Helpful On-Line information | A-7 |
| SolidWorks Document types | A-8 |

| | |
|-----------------|------------|
| Glossary | G-1 |
|-----------------|------------|

| | |
|--------------|------------|
| Index | I-1 |
|--------------|------------|

 Instructors' information contains over 45 classroom presentations, along with helpful hints, what's new, sample quizzes, avi files of assemblies, projects, and all initial and final SolidWorks models.

| | |
|---|---|
| <ul style="list-style-type: none">  Alphabet of lines and Precedent of Line Types  Annotations in Drawings  Assembly Envelope  Baseline vs Chain dimensioning  Boolean Operation  Calipers - General  Create an Assembly document  Design Intent  Different Sketch types  Dimensioning Rules  Drafting Standards & Dimensioning Systems  Drawing Dimension Alignment tool - Dimension Palette  Equations in General  Fasteners in General  Flex Feature  Freeform Feature  Gears using SolidWorks  General 2D Sketch Tips  General GDT information  General Mate Tips | <ul style="list-style-type: none">  General Modeling Strategy and 3D Modeling Features  General SolidWorks Tips  General Tolerance and FIT  Global vs. Local Coordinate system  Hidden vs. Suppress in an Assembly  History of Engineering Graphics  Intersect Feature  Layout Assembly Design  Mate Types in SolidWorks  Materials in General  Measurement and Scale  Multi-body Parts  Non-Standard Drawing View Types  Open a Drawing Document  Open an Assembly Document  Part and Drawing (Dimensioning)  Planes, Design Tables and Configurations  Primitives - Basic Shapes  Projected Curve Feature  Projection, Arrangement and Visualization of Views  Save As Copy in SolidWorks |
|---|---|

