

Package Structure & Mechanism Design with SolidWorks

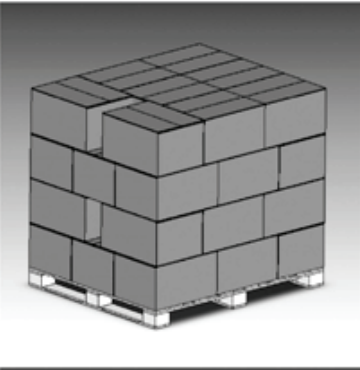

2011

Changfeng Ge

Rochester Institute of Technology

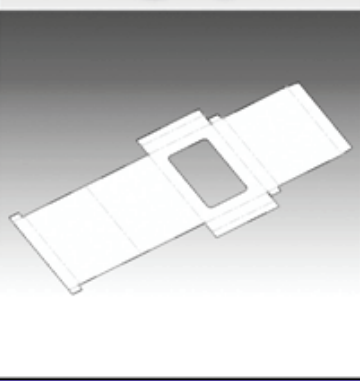
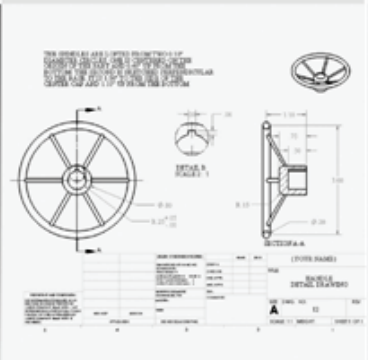
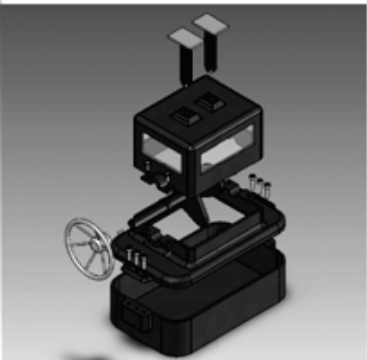
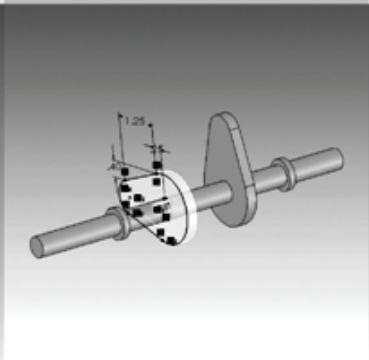
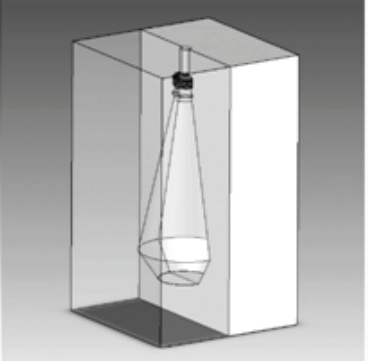
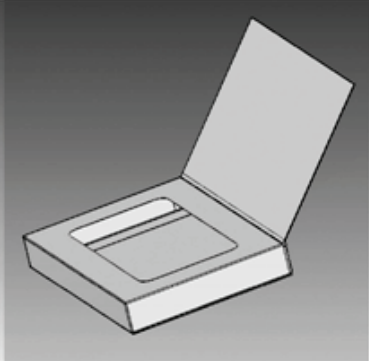

SDC
PUBLICATIONS

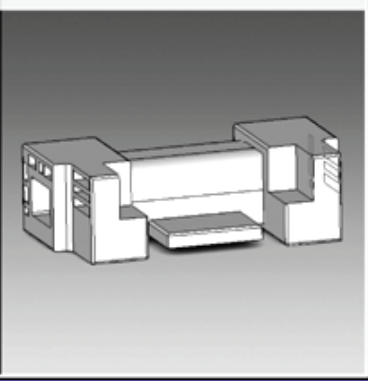

Table of Contents

Introduction

1. Cushion Design for a Printer
2. Design of a Bottle and a Cap
3. Design of a Corrugated Box and a Divider
4. Design of a pallet
5. Assembly of the Corrugated Box, the Divider and the Bottle
6. Design of an Apple Tray
7. Design of a Gift Box
8. Mold Design for the Bottle
9. Placing a Label on the Bottle
10. Design of a Cam Shaft
11. Design of a Turn Handle
12. Detail Drawing for the Cam Shaft
13. Detail Drawing for the Turn Handle
14. Compiled Detail Drawing of the Cam Gear Housing
15. Assembly of the Cam and Gear Housing
16. Exploded View of the Cam Gear Housing
17. Assembly Drawing of the Cam Gear Housing