

Modeling Using Pro | ENGINEER W I L D F I R E 4.0

Sridhar Condoor

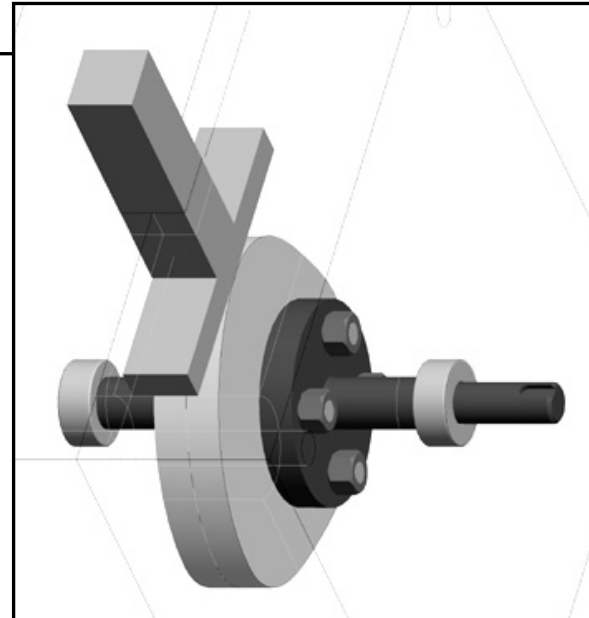

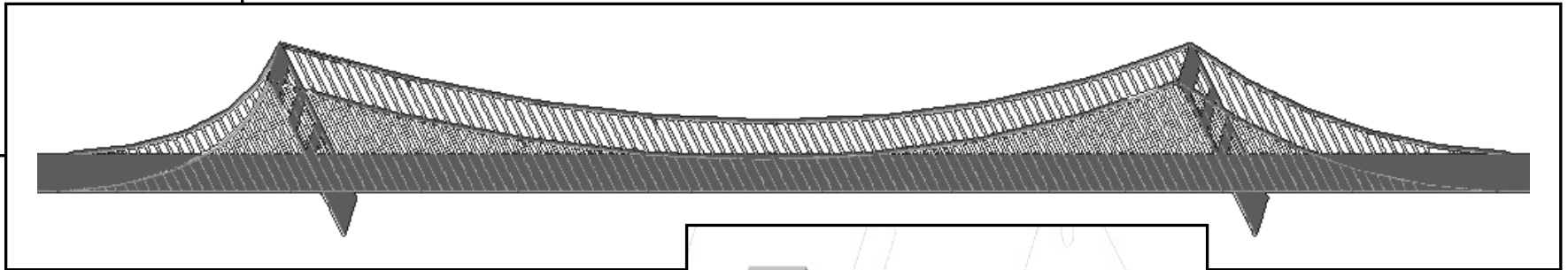

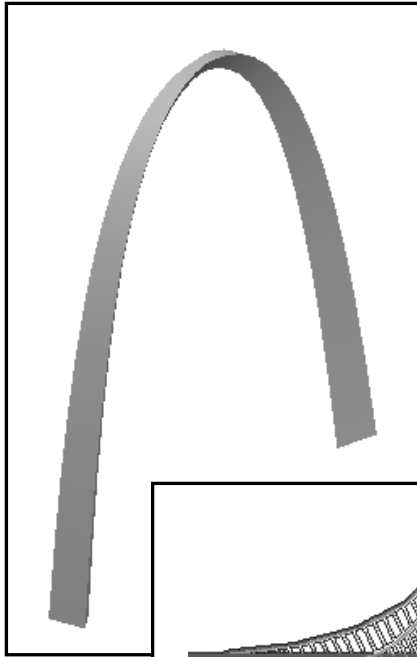





SDC
PUBLICATIONS

Schroff Development Corporation
www.schroff.com

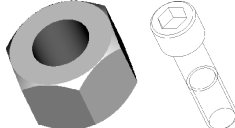
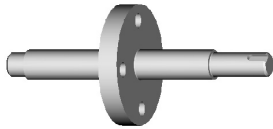
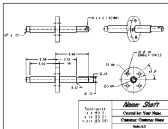
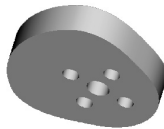
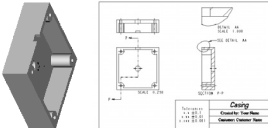
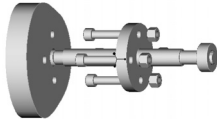
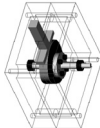
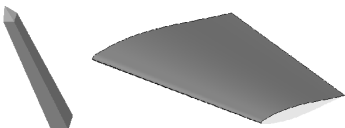
Better Textbooks. Lower Prices.

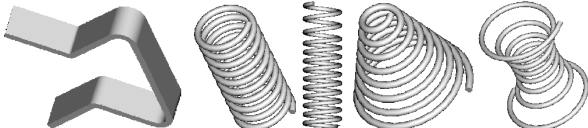
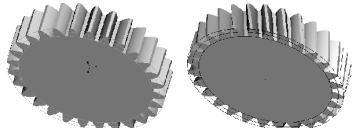
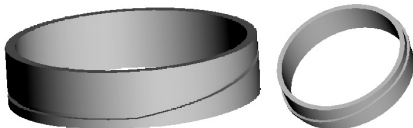
TABLE OF CONTENTS

<p>1. Introduction – Page 1</p>	<p>2. Bearing – Page 5</p> 	<p>3. Bearings – Page 31</p> 
<p>4. Bushing – Page 47</p> 	<p>5. Retaining Ring – Page 63</p> 	<p>6. Nuts and Bolts – Page 79</p> 
<p>7. Shaft – Page 97</p> 	<p>8. Shaft Drawing – Page 117</p> 	<p>9. Radial Plate Cam – Page 133</p> 
<p>10. Housing – Page 147</p> 	<p>11. Cam Assembly – Page 163</p> 	<p>12. Cam Follower Assembly – Page 179</p> 
<p>13. Washington Monument and Wing – Page 193</p> 	<p>14. Gateway Arch – Page 209</p> 	<p>15. Springs – Page 223</p> 
<p>16. Spur and Helical Gears – Page 237</p> 	<p>17. Axial Cam – Page 255</p> 	<p>18. Grooved Cam – Page 265</p> 
<p>19. Bolt Heads – Page 275</p> 		<p>20. Electrical Fuse Assembly – Page 289</p> 