

Visit the following websites to learn more about this book:



[amazon.com](https://www.amazon.com)

[Google books](https://books.google.com)

[BARNES & NOBLE](https://www.barnesandnoble.com)

# 1: Introduction

---

## *Topics covered*

- ❑ Heat transfer by conduction
- ❑ Heat transfer by convection
- ❑ Heat transfer by radiation
- ❑ Thermal boundary conditions
- ❑ Analogies between thermal and structural analysis
- ❑ Thermal elements: solids and shells
- ❑ Scalar and vector entities, presenting results
- ❑ Steady state thermal analysis
- ❑ Transient thermal analysis
- ❑ Linear thermal analysis
- ❑ Nonlinear thermal analysis

## *What is Thermal Analysis?*

Thermal analysis deals with heat transfer in solid bodies. We approach thermal analysis from the perspective of a user experienced in structural analysis such as static, modal, buckling etc. as implemented in **SOLIDWORKS Simulation**. You will soon notice that experience in structural analysis is directly transferable to thermal analysis because of the close analogies between structural and thermal analyses. The temperature is analogous to displacement in structural analysis, strain to temperature gradient, and stress to heat flux. Selected analogies are summarized in Figure 1-1.

Structural Analysis	Thermal Analysis
Displacement [m]	Temperature [K]
Strain [1]	Temperature gradient [K/m]
Stress [N/m <sup>2</sup> ]	Heat flux [W/m <sup>2</sup> ]
Load [N] [N/m] [N/m <sup>2</sup> ] [N/m <sup>3</sup> ]	Heat source [W] [W/m] [W/m <sup>2</sup> ] [W/m <sup>3</sup> ]
Prescribed displacement [m]	Prescribed temperature [K]
Pressure [N/m <sup>2</sup> ]	Prescribed heat flux [W/m <sup>2</sup> ]
Hook's law: $\sigma = E \frac{du}{dx}$	Fourier's law: $q = -k \frac{dT}{dx}$
Stiffness matrix	Conductivity matrix

Figure 1-1: Analogies between structural and thermal analyses with units in SI system.

*Different system of units may be used except for radiation problems where temperature is absolute and must be expressed in Kelvins.*

The primary unknown in structural analysis is displacement; the primary unknown in thermal analysis is temperature. This leads to an important difference between structural and thermal analysis performed with the finite element method. Displacement, which is a vector and includes both translation and rotation, requires up to six degrees of freedom per node. The number of degrees of freedom in structural analysis depends on the type of elements; for example, solid elements have three degrees of freedom and shell elements have six degrees of freedom per node. Two dimensional structural elements have two degrees of freedom per node. Temperature is a scalar and requires only one degree of freedom per node, regardless of element type. This makes thermal problems much easier to solve because thermal models typically have fewer degrees of freedom as compared to structural models.

Another conceptual difference is that thermal analysis is never a “static” analysis. If heat flow does not change, then the problem is “steady state analysis” and not static because heat flow never stops. If heat flow changes with time, then the problem is called transient.

## ***Mechanisms of heat transfer***

### **Conduction**

In a solid body, the energy is transferred from a high temperature region to a low temperature region. The rate of heat transfer per unit area is proportional to the material thermal conductivity, cross sectional area and temperature gradient in the normal direction; it is inversely proportional to the distance (Figure 1-2). This mode of heat transfer is referred to as conduction:

$$Q_{COND} = kA(T_{HOT} - T_{COLD})/L$$

Where:

$Q_{COND}$  – Heat transferred by conduction [W]

$k$  – Thermal conductivity [W/m/K]

$A$  – Cross sectional area [m<sup>2</sup>]

$T_{HOT}$  – Temperature on the hot side [K]

$T_{COLD}$  – Temperature on the cold side [K]

$L$  – Distance of heat travel [m]

Conduction is responsible for heat transfer inside a solid body.

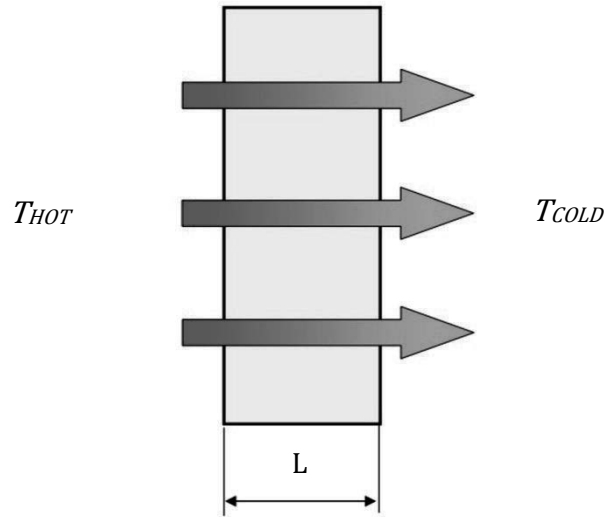

Figure 1-2: Heat transfer by conduction.

*Conduction is responsible for heat transfer inside a solid body.*

Thermal conductivity is vastly different for different materials as shown in Figure 1-3.

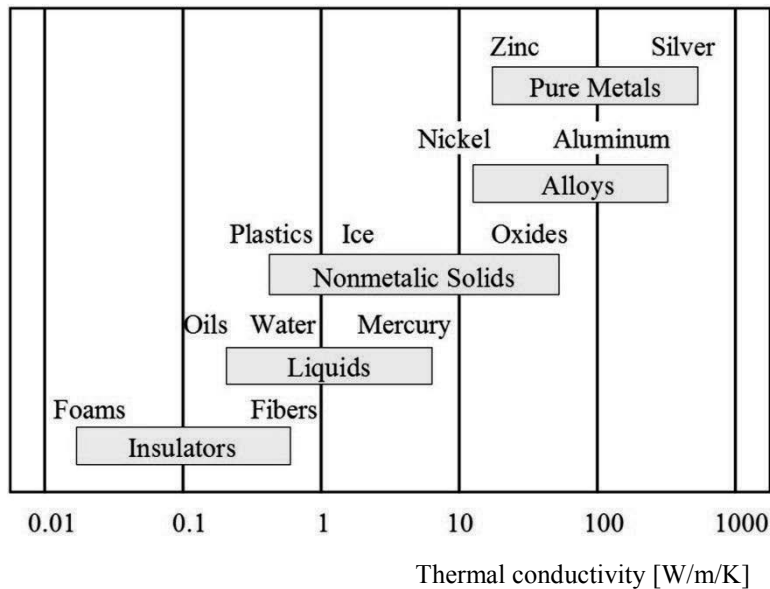

Figure 1-3: Thermal conductivity for different materials.

*There are five orders of magnitude difference in thermal conductivity between the best conductors and best insulators.*

### Convection

Convective heat transfer is the heat flow between a solid body and the surrounding fluid (either liquid or gas). Convective heat transfer can be either natural convection where the fluid flow is due to the variation in specific weight of a hot and cold fluid, or forced convection where the fluid is forced to flow past the solid body. Therefore, natural convection requires gravity (Figure 1-4), and forced convection does not require gravity (Figure 1-5). Since fluid (air, water, steam, oil etc.) is required for heat transfer by convection, this type of heat transfer cannot happen in a vacuum. Heat exchanged by convection is expressed as:

$$Q_{CONV} = hA(T_S - T_F)$$

Where:

$Q_{CONV}$  – Heat transferred by convection [W]

$h$  – Convection coefficient [W/m<sup>2</sup>/K]

$A$  – Surface area [m<sup>2</sup>]

$T_S$  – Surface temperature [K]

$T_F$  – Fluid bulk temperature [K]

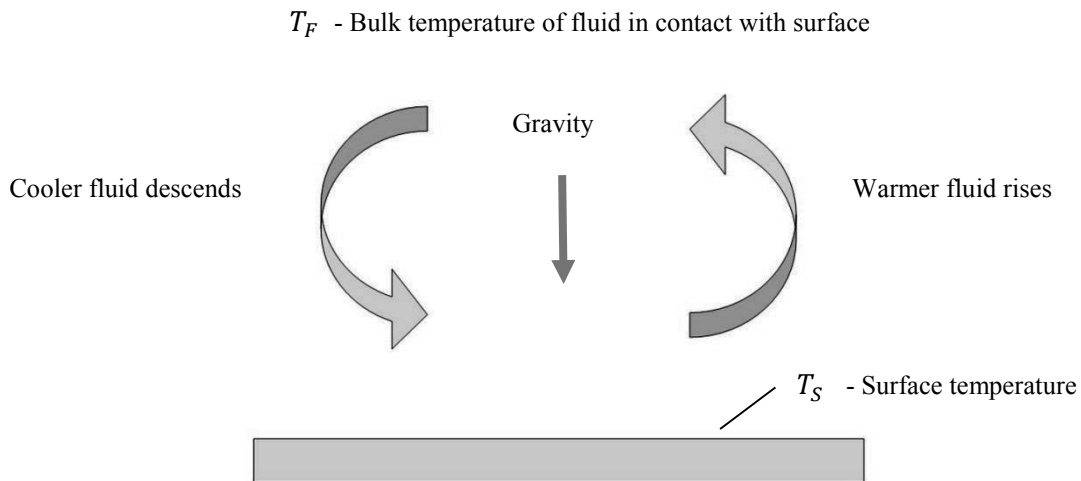

Figure 1-4: Heat transfer by natural convection.

*Convective heat transfer can take place only in the presence of fluid and gravity.*

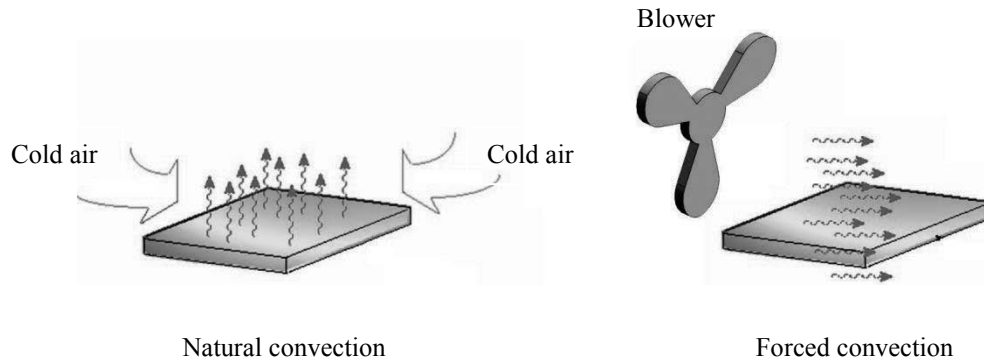

Figure 1-5: Natural and forced convection.

*Forced convection doesn't require gravity.*

The magnitude of the convection coefficient strongly depends on the medium (fluid) surrounding a solid body (Figure 1-6).

Medium	Convection coefficient W/m <sup>2</sup> /K
Air (natural convection)	5-25
Air/superheated steam	20-300
Oil (forced convection)	60-1800
Water (forced convection)	300-6000
Water (boiling)	3000-60000
Steam (condensing)	6000-120000

Figure 1-6: Convection coefficient for different media.

*There are five orders of difference in convection coefficients between different media and different types of convection.*

### **Radiation**

Radiation heat transfer occurs between a solid body and the ambient or between two solid bodies without presence of any medium (fluid). This is the only type of heat transfer that occurs in a vacuum. Heat flows by electromagnetic radiation. The upper limit to the emissive power is a black body radiating heat and is prescribed by the Stefan-Boltzmann law:

$$q = \sigma T_s^4$$

Where:

$q$  – Heat flux (heat emitted by radiation per unit of area) [W/m<sup>2</sup>]

$\sigma$  – Stefan-Boltzmann constant =  $5.67 \times 10^{-9}$  [W/m<sup>2</sup>/K<sup>4</sup>]

$T_s$  – Surface temperature [K]

The heat flux emitted by a real surface is less than that of a black body at the same temperature. It is given as:

$$q = \epsilon \sigma T_s^4$$

where  $\epsilon$  is a radiative property of a surface called emissivity. Values of  $\epsilon$  are in the range of  $0 \leq \epsilon \leq 1$  and provide a measure of how well the surface emits radiative energy in comparison to a black body. It depends strongly on the surface material and finish. For example, a polished aluminum surface has an emissivity of about 0.05; an oxidized aluminum surface has an emissivity of 0.25. The emissivity also depends on the temperature of the face emitting heat by radiation.

In heat transfer by radiation, heat may be radiated out to space by a single body; it may be exchanged between two bodies or it may be exchanged between two bodies as well as radiated out to space (Figure 1-7).



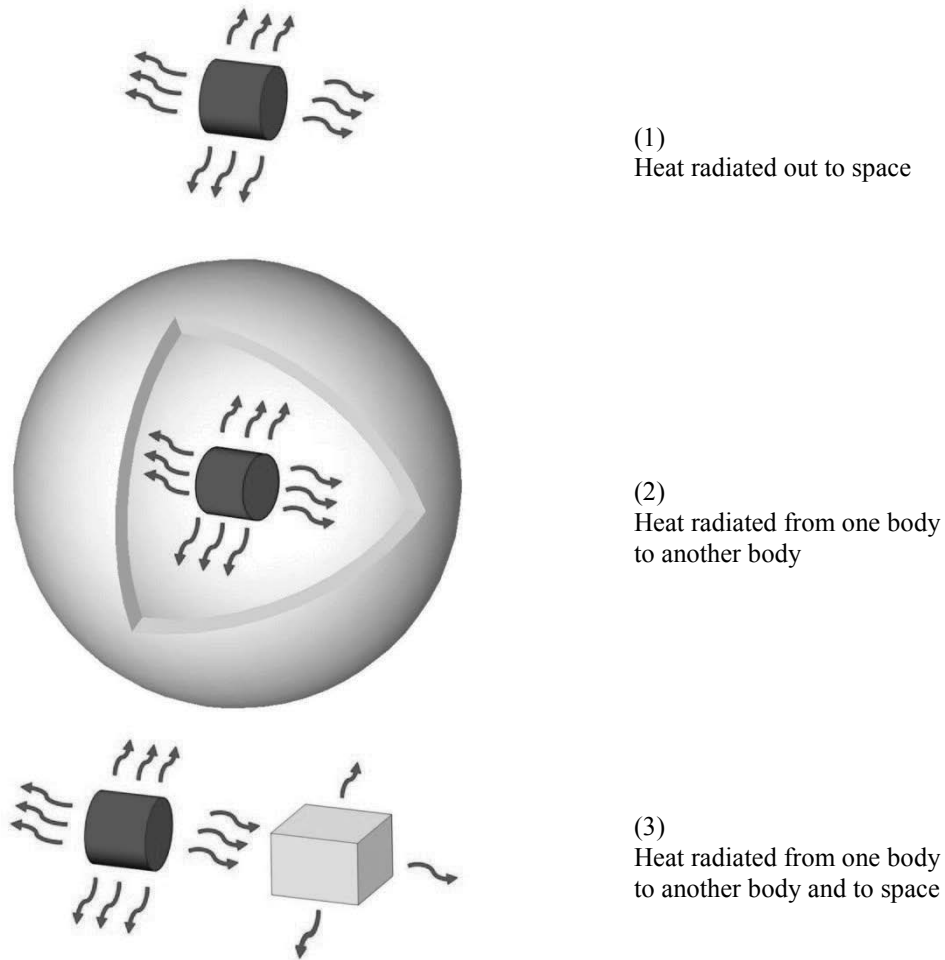

Figure 1-7: Different cases of heat transfer by radiation.

*If heat is exchanged between two bodies only and not radiated out to space, then one body must be fully enclosed by the other body (2). Heat gained by radiation may be radiated out again into space (3).*

Having introduced three mechanisms of heat transfer we need to make a very important statement. With **SOLIDWORKS Simulation** which uses the finite element method, only heat transfer by conduction is modeled directly. Convection and radiation are modeled as boundary conditions. This is done by defining convection and/or radiation coefficients to faces that participate in heat exchange between the model and the environment.

The next two examples show how a prescribed temperature, convection and heat load work together to induce heat flow inside a solid body. These examples are not hands-on exercises. Hands-on exercises will start in chapter 2.

### ***Heat Flow Induced By Prescribed Temperatures***

Just like stresses may be caused by prescribed displacement, heat flow may be induced by temperature differences defined by prescribed temperatures. Consider the model BRACKET TH with different temperatures defined on two faces as shown in Figure 1-8. Note that the temperature field establishes itself in the model but heat flow continues due to temperature gradients. Also notice that no heat escapes from the model because we have not defined any mechanism to exchange heat through any surfaces other than the two faces with prescribed temperatures. This implies that the model is perfectly insulated, except for two faces where prescribed temperatures are defined and may correspond to a situation where the bracket holding a hot pipe is mounted on a cold surface and heat escaping through faces exposed to air is negligible.

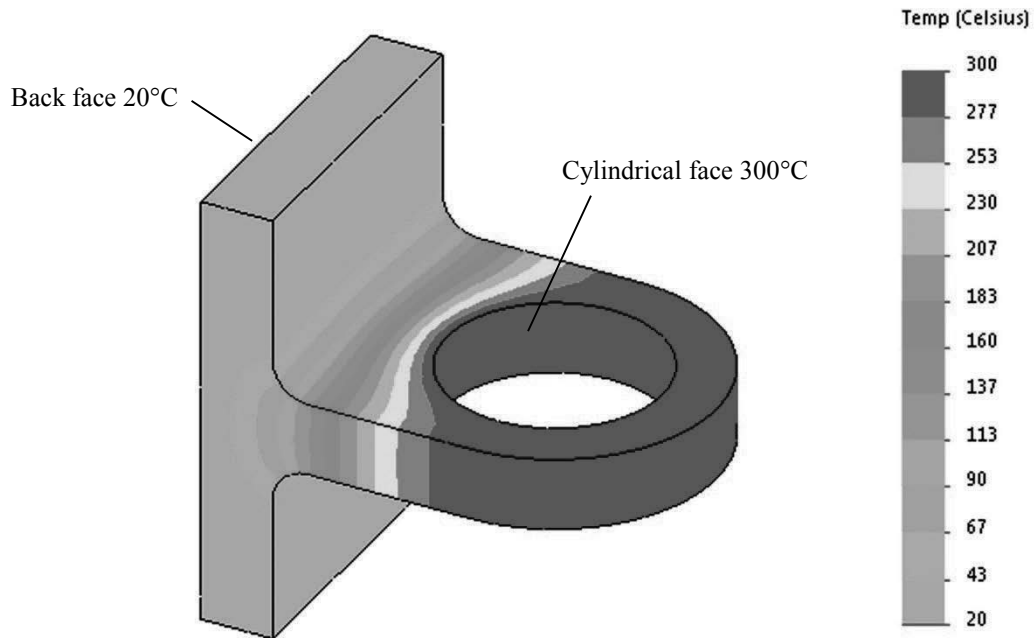

Figure 1-8: Temperature distribution in the model where heat flow is induced by prescribed temperatures.

*A temperature of 300°C is applied to the cylindrical face, and a temperature of 20°C is applied to the back face.*

Plot in Figure 1-8 uses custom colors (grey substituted for blue) to improve black and white print quality. Custom colors will be used frequently to present fringe plots in this book. Custom colors may be defined in **Chart Options** in plot settings.

### ***Heat flow induced by heat load and convection***

Heat flow can also be induced by the applied heat load. The unit of heat load applied to a surface is called heat flux; heat flowing through an imaginary cross-section is also called heat flux. Total heat applied to a volume or face is called heat power. Notice that since thermal analysis deals with heat flow, a mechanism for that heat flow to occur must be in place. In the heat sink problem HEAT SINK01, shown in Figure 1-9, heat enters the radiator model through the base, as defined by the applied heat power which is a close analogy to force load in structural analysis. Convection coefficients [ $\text{W}/\text{m}^2/\text{K}$ ], also called film coefficients, are defined for all remaining surfaces and provide the way to remove heat from the model. Heat enters the model through the base where heat power is defined. Heat escapes the model through faces where convection coefficients are defined.

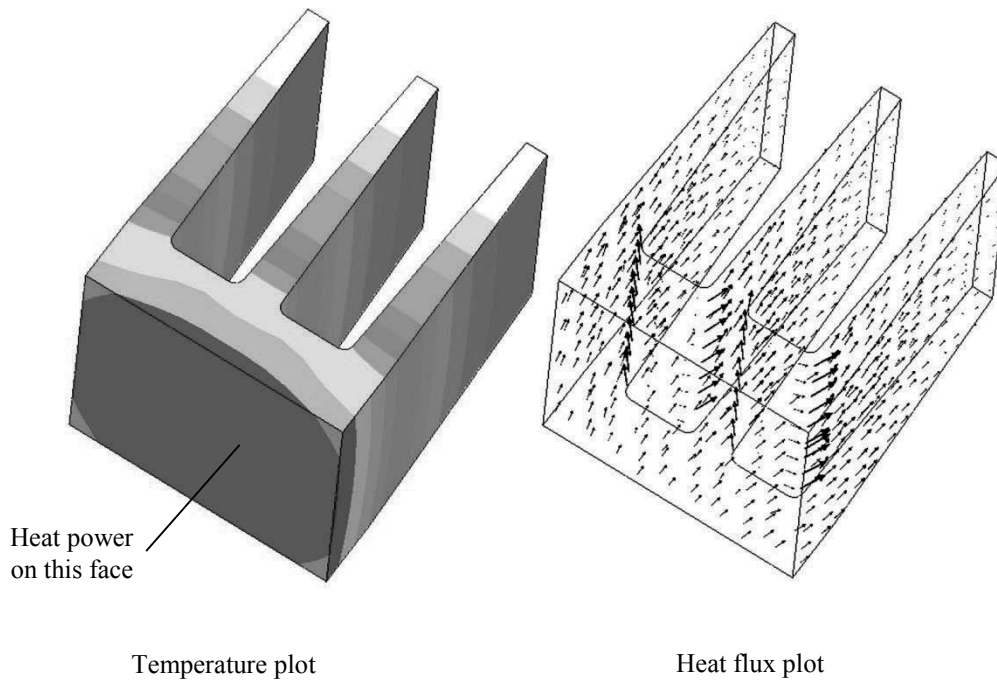

**Figure 1-9: Temperature distribution and heat flux in a heat sink model.**

*A temperature plot being a scalar quantity can only be shown using a fringe display. Heat flux is a vector quantity and can be illustrated either by a fringe plot or vector plot. Notice that arrows “coming out” of the walls illustrate heat that escapes the model because of convection.*

The structural analogy of convection coefficients is a bit less intuitive. Convection coefficients are analogous to elastic support offered by distributed springs. Just like supports and/or prescribed displacements are necessary to establish model equilibrium in a structural analysis problem, convection coefficients and/or prescribed temperatures are necessary to establish heat flow in a thermal analysis problem. Indeed, an attempt to run thermal analysis with heat loads but with no convection coefficients or prescribed temperatures results in an error similar to the one caused by the absence of supports in structural analysis.

### ***Modeling considerations in thermal analysis***

Symmetry boundary conditions can be used in thermal analysis based on the observation that if symmetry exists in both geometry and boundary conditions, then there is no heat flowing through a plane of symmetry. After simplifying the model to  $\frac{1}{2}$  in case of single symmetry or to  $\frac{1}{4}$  in case of double symmetry (Figure 1-10), nothing needs to be done to surfaces exposed by cuts. No convection coefficients defined for those surfaces means that no heat flows across them.

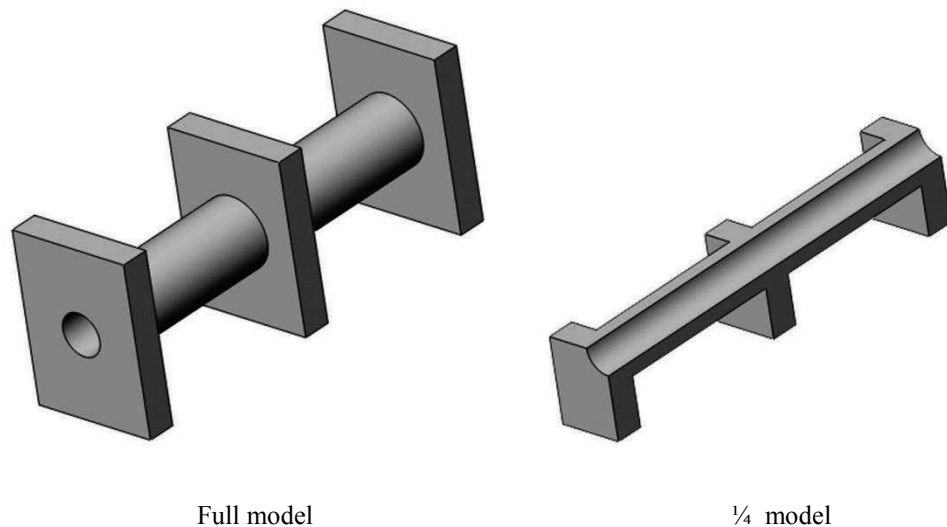

Figure 1-10: Model DOUBLE SYM with double symmetry can be simplified to  $\frac{1}{4}$  of its size.

*No thermal boundary conditions are applied to faces in the plane of symmetry.*

Axisymmetric problems may be represented by 2D models as shown in Figure 1-11.

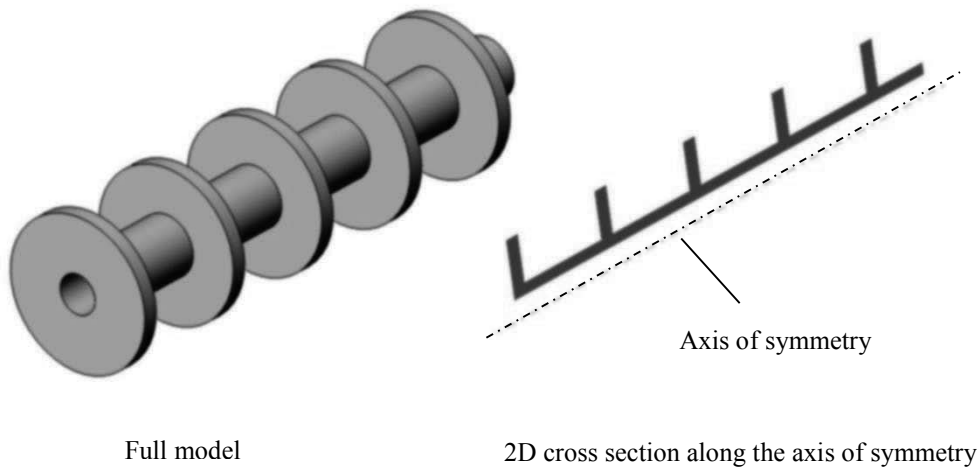

Figure 1-11: Axisymmetric model AXISYM represented by a 2D cross section.

Notice that models DOUBLE SYM (Figure 1-10) and AXISYM (Figure 1-11) are suitable for analysis of temperature, but because of sharp re-entrant edges, they are not suitable for analysis of heat flux in the vicinity of the sharp re-entrant edges because heat flux there is singular. This is in direct analogy to sharp re-entrant edges causing stress singularities in structural models.

Once you acquire sufficient familiarity with thermal analysis you are encouraged to analyze models BRACKET TH, HEAT SINK01, DOUBLE SYM and AXISYM using thermal parameters of your choice.

Let's wrap up this review with an important observation which will serve as a guide to all thermal analysis problems. In structural analysis we define a load path by defining loads and supports. In a heat transfer problem, we define a mechanism of heat transfer; we must know how heat enters the model, how it travels through the model and how it exits the model.

### ***Types of thermal analysis***

Thermal analysis may be linear or nonlinear, steady state or time-dependent as shown in Figure 1-12.

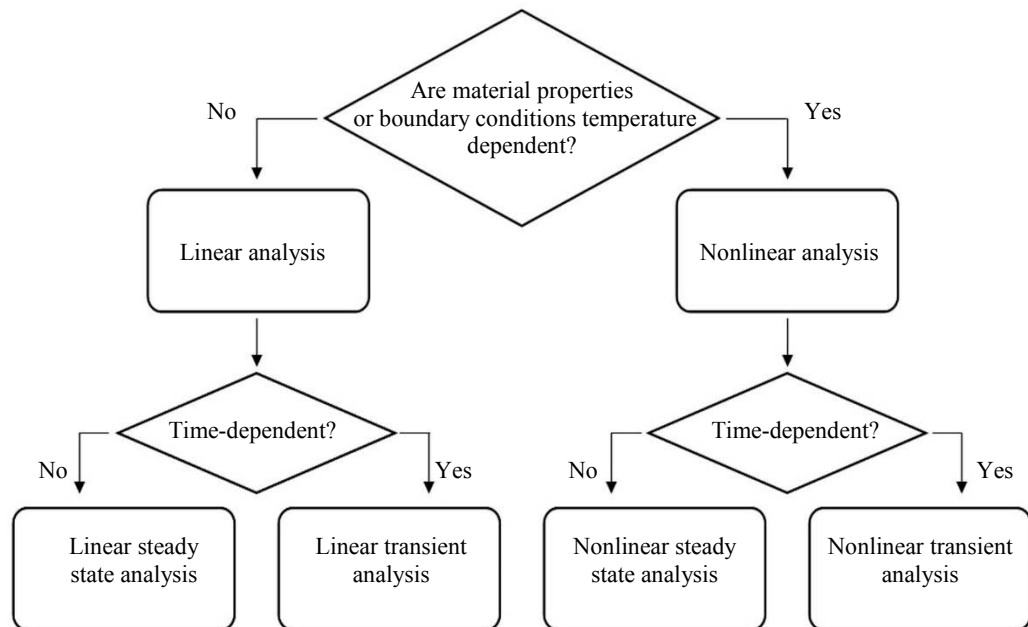

Figure 1-12: Types of thermal analyses.

In linear analysis, the conductivity matrix does not change during the solution process; in nonlinear analysis it must be modified because material properties and/or boundary conditions are temperature dependent. In steady state analysis, material conditions and boundary conditions do not change with time; in time dependent (transient) they do change.

We will be working with all of types of thermal analyses shown in Figure 1-12.

### ***Thermal analysis with SOLIDWORKS Simulation***

**SOLIDWORKS Simulation** uses methods of finite element analysis to solve both structural and thermal problems. CAD models prepared in **SOLIDWORKS** are discretized (meshed) into finite elements. The elements' type depends on the type of geometry prepared in **SOLIDWORKS**. Solid bodies are meshed into solid elements; Surface bodies are meshed into shell elements; 2D axisymmetric and extruded models are meshed into corresponding 2D elements. Types of finite elements, meshing techniques and other mesh specific considerations are discussed in details in the pre-requisite text "**Engineering Analysis with SOLIDWORKS Simulation.**" Here we limit our review to thermal analysis specific issues.

Elements available in thermal analysis with **SOLIDWORKS Simulation** are shown in Figure 1-13. Notice that beam elements are not available in thermal analysis.

	3D elements		2D elements
	Solid elements	Shell elements	Axisymmetric elements Extruded elements
<b>First order element</b> Linear (first order) temperature field Constant heat flux field			
<b>Second order element</b> Parabolic (second order) temperature field Linear heat flux field			

Figure 1-13: Elements available in thermal analysis with SOLIDWORKS Simulation.

*The majority of analyses use the second order tetrahedral element.*

First order elements do not offer any advantages in either structural or thermal analysis and beam elements are neither applicable nor available in thermal analysis. Therefore we are left with second order solids and second order shells to model 3D problems and second order plate elements to model 2D axisymmetric or extruded problems.

Prior to commencing work with thermal problems, make sure that **Solid Bodies** and **Surface Bodies** are visible in the **SOLIDWORKS** Feature Manager (Figure 1-14).

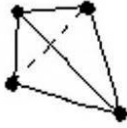
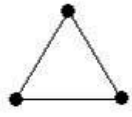
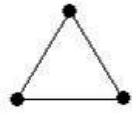
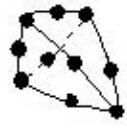
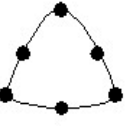
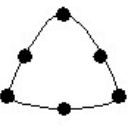
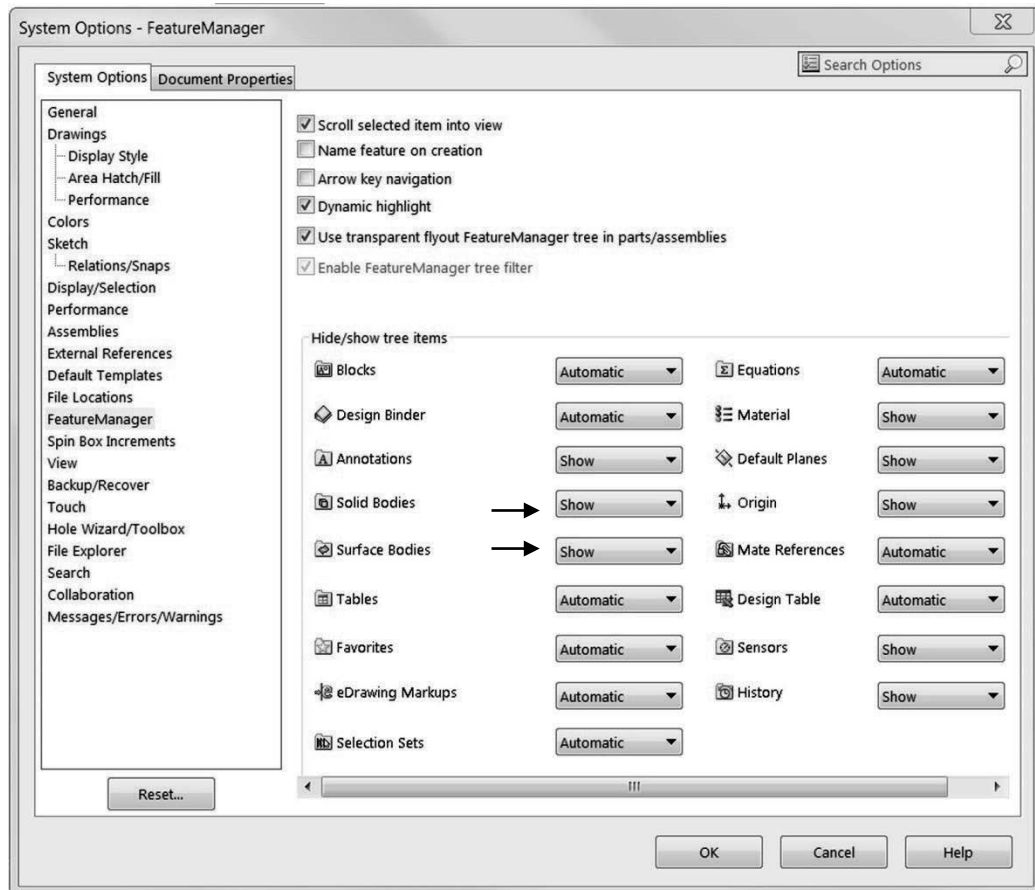

Figure 1-14: Settings of Feature Manager.

*To facilitate working with Simulation models make sure that Solid Bodies and Surface Bodies are always visible.*