



The *Unofficial* **Revit 2010 Certification** **Exam Guide**



Elise Moss

SDC
PUBLICATIONS

Schroff Development Corporation

www.schroff.com

Lesson Two

The Basics of Building a Model

This lesson addresses the following Associate and Professional level exam questions:

- Wall Properties
- Compound Walls
- Doors and Windows

In the Professional exam, most of the wall problems follow these steps:

- Place a wall of a specific element type. (Be able to select wall type.)
- Place a wall by setting the location line. (Understand how to use the location line setting.)
- Place a wall using different Option Settings. (Understand how to use the Options Settings when placing a wall.)
- After placing the wall, place a dimension to determine if the wall was placed correctly.
- After placing the wall, inspect the element properties to determine if the wall was placed correctly.

In the Associate exam, the user will need to be familiar with the different parameters in walls and compound walls. The user should also know which options are applied to walls and when those options are available.

Command Exercise

Exercise 2-1 – Wall Options

Drawing Name: **i_firestation_basic_plan.rvt**

Estimated Time to Completion: 10 Minutes

Scope

Exploring the different wall options

Solution

1. Activate the **Ground Floor** floor plan.

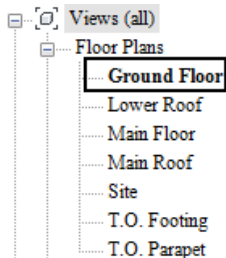

2. Zoom into the area where the green polygon is.

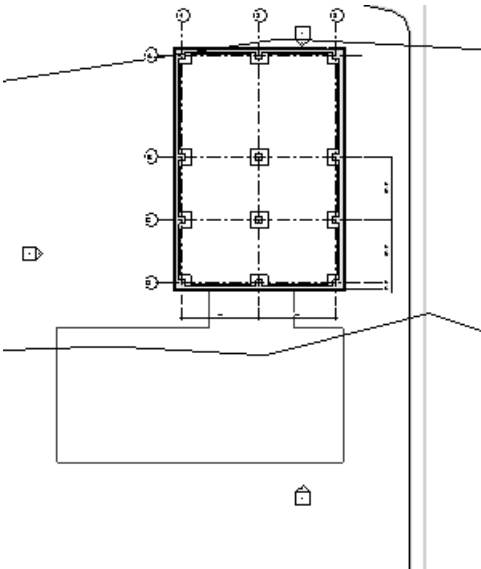

3. Select **Wall** from the Home ribbon.



4. Set the Wall Type to **Generic – 6"**.

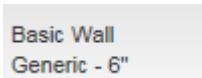

5. Set the Location Line to **Core Face:Exterior**.

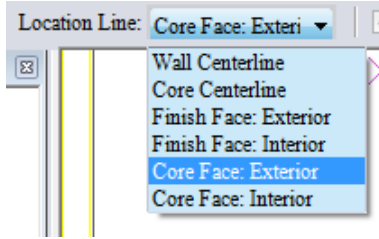

6. Select the **Rectangle** tool.

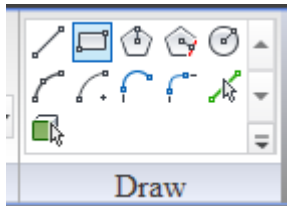

7. Select the two points indicated to place the rectangle.

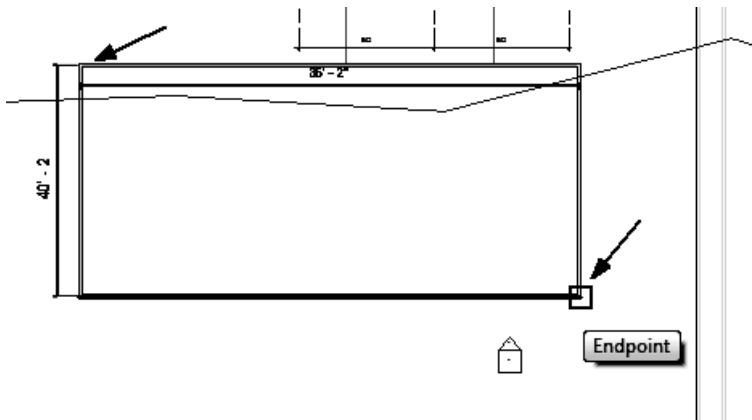

8. Select the **Line** tool.



9. Start the line at the midpoint of the lower horizontal wall.

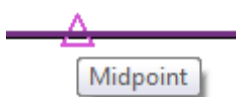

10. Bring the line end up to the midpoint of the upper horizontal wall.

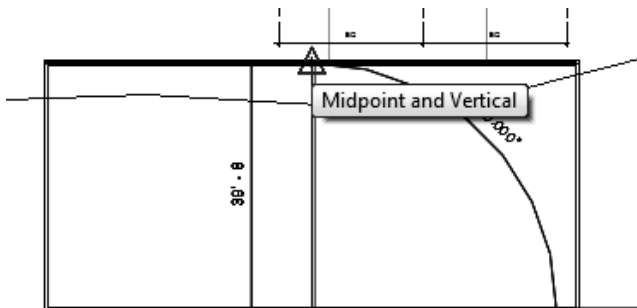

Left click to finish placing the wall.

11.

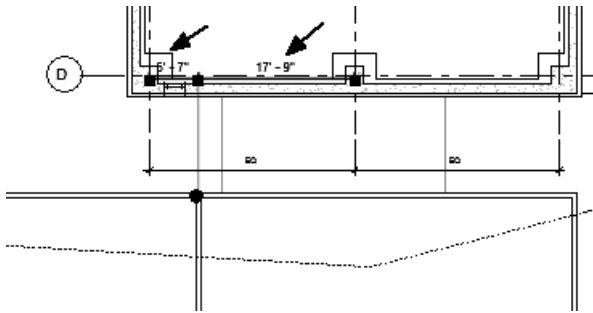

Select the vertical wall.
Two temporary (listening) dimensions will appear.

Change the right dimension to **12'[3600 mm]**.

12.

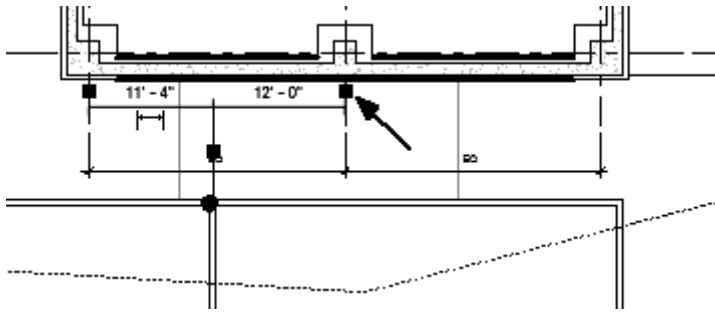

Select the witness grip point indicated.

13.

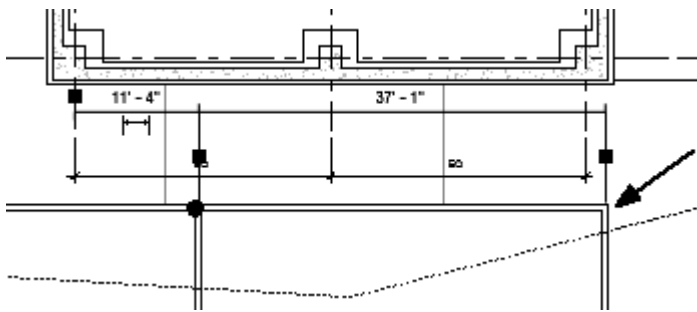

Move the witness line to the right vertical wall.

Note that the dimension updates.

14. Close the file without saving.

Command Exercise

Exercise 2-2 – Placing a Wall Sweep

Drawing Name: **i_walls.rvt**

Estimated Time to Completion: 20 Minutes

Scope

Placing a wall sweep.

Solution

- 

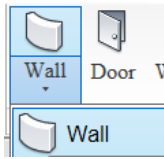
1. Activate **Level 1** Floor Plan.
- 

2. Select the **Wall** tool from the Home ribbon.
- 

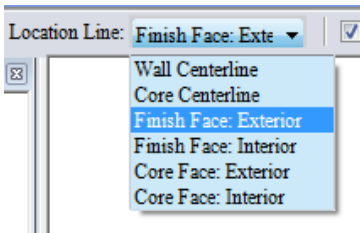
3. Set the wall type to **Exterior - Brick on Mtl. Stud**.
- 

4. Set the Location Line to **Finish Face: Exterior**.
- 

5. Select the **Pick Line** mode.
Select the four green lines.
6. Type **VV** to bring up the Visibility/Graphics dialog.

7. Enable the visibility of Elevations.
Press **OK**.

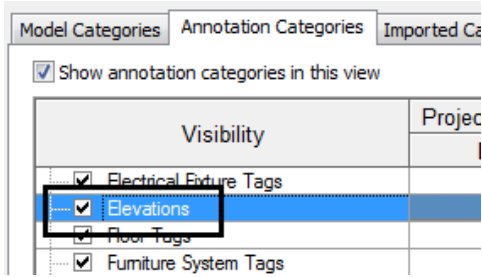

8. Activate the **View** ribbon.
Select the **Elevation** tool.

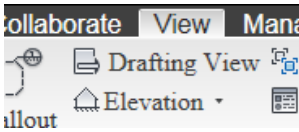

9. Place an elevation facing each of the interior walls.

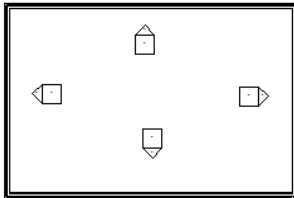

10. Rename the elevation views to East Interior, North Interior, South Interior and West Interior.

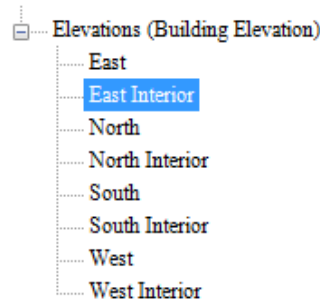

11. If you mouse over the triangle part of the elevation, you will see the name of that elevation view.



12. If you pick on the triangle part of the elevation, you will see the view range of that elevation view.

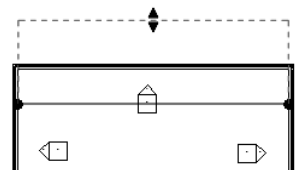

13. Activate the **South Interior View**.

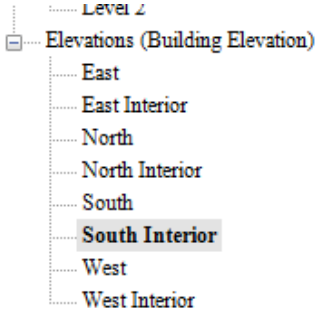

14. Activate the **Home** ribbon.
 Select the **Wall Sweep** tool.

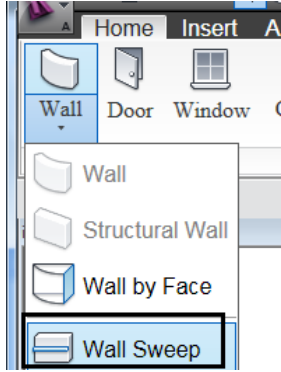

The Wall Sweep tool is only available in elevation, 3D or section views.

15.  Place the sweep so it is toward the top of the wall.

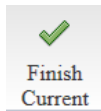

Select **Finish Current**.

16.  Switch to a 3D view.

17.  Select the wall sweep that was placed.
 It will highlight when selected.

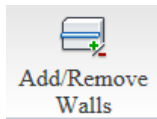
18.  Select **Add/Remove Walls** from the ribbon.
 Select the other walls.
 Orbit around to inspect.

19. Save as *ex2-2.rvt*.

Command Exercise

Exercise 2-3 – Create a Wall Sweep Style

Drawing Name: **ex2-2.rvt**

Estimated Time to Completion: 15 Minutes

Scope

*Creating a wall sweep style.
Loading a Profile.*

Solution:

1.  Activate the **South Interior** View.

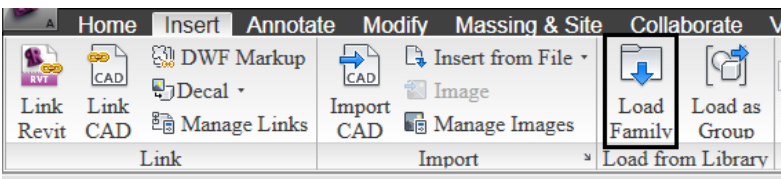
2.  Activate the **Insert** ribbon.
Select **Load Family**.

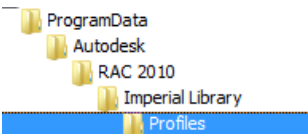
3.  Browse to the **Profiles** folder.

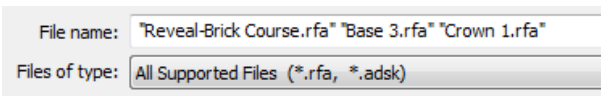
4.  Load the following profiles:
Base-3.rfa
Crown 1.rfa
Press **Open**.

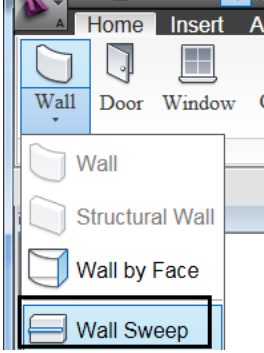
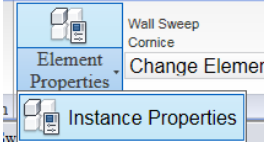
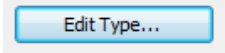
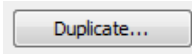
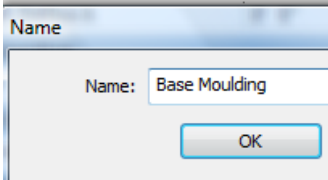
5.  Activate the **Home** ribbon.
Select the **Wall Sweep** tool.
The Wall Sweep tool is only available in elevation, 3D or section views.
6.  Select **Element Properties** → **Instance Properties**.
7.  Select **Edit Type**.
8.  Select **Duplicate**.
9.  Enter **Base Moulding** in the Name field.
Press **OK**.
10.

Construction	
Profile	Base 3 : 3 1/2" x 9/16"
Materials and Finishes	
Material	Plastic - Vinyl Cove Base

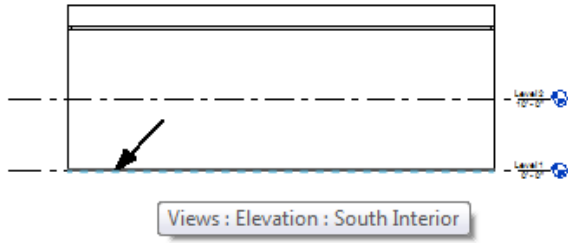
Set the Profile to **Base 3 : 3 1/2" x 9/16"**.
Set the Material to **Plastic – Vinyl Cove Base**.
Press **OK** twice to exit the dialog.
11.  Place the baseboard on the bottom of the wall.

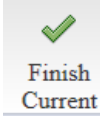
Views : Elevation : South Interior
12.  Select **Finish Current**.
13. Save as *ex2-3.rvt*.

Command Exercise

Exercise 2-4 – Create a Custom Profile

Drawing Name: **ex2-3.rvt**

Estimated Time to Completion: 20 Minutes

Scope

*Creating a custom profile.
Using the custom profile in a wall sweep.*

Solution

1.  Select **Open**.

2.  Scroll on the left pane to the **Imperial Library**.

3.  Browse to the **Profiles** folder.

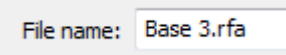
4.  Open *Base 3.rfa*.

5. Save the file as *Base 4.rfa*.

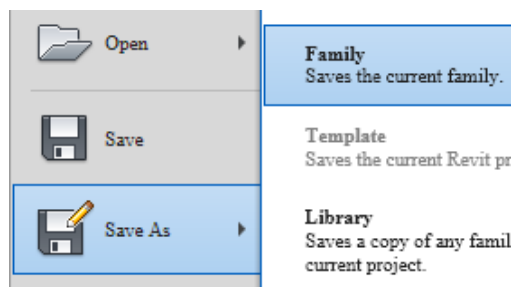

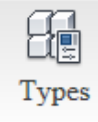
6.  Select the **Types** tool.

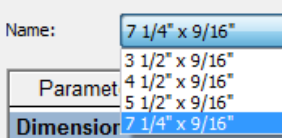
7.  Note that several sizes are available for this profile.

Use the Apply button to see how the profile changes depending on the size selected.

8.  Modify the profile.

I eliminated the offset on the left and simplified the top.

Verify that the profile still flexes properly using the different types.

9. Save the new profile.

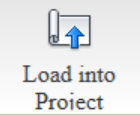
10.  Activate the Create ribbon.

Select **Load into Project**.

11. Close the family file.

12.  Activate the **South Interior View**.

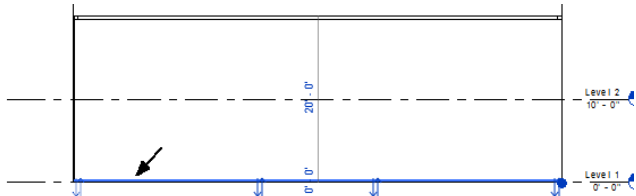
13.  Select the base wall sweep.

14.  Select **Type Properties**.

15.  Select **Base 4: 3 1/2" x 9/16"**.

This is the new profile you just created and loaded into the project.

16. Save as *ex3-4.rvt*.

Command Exercise

Exercise 2-5 – Create a Compound Wall

Drawing Name: **ex2-4.rvt**

Estimated Time to Completion: 40 Minutes

Scope

*Creating a custom profile.
Using the custom profile in a Compound Wall.*

Solution

1.  Select **New** → **Family**.

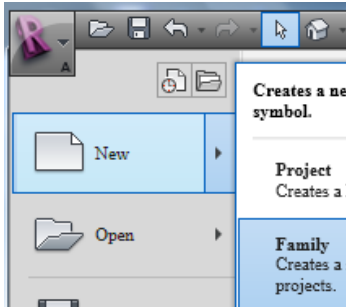

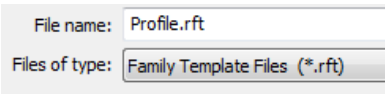
2.  Locate the *Profile.rft* file.
Select **Open**.

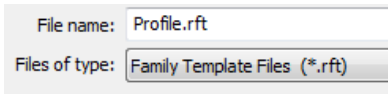

3.  Select the **Line** tool.

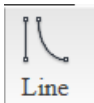

4.  Select the **Rectangle** tool.

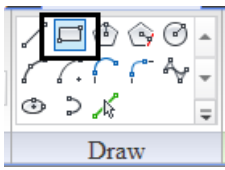

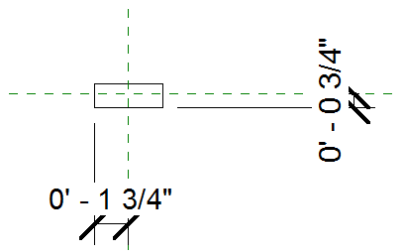
5.  Create a rectangle that is 1.5" x 3.5" centered on the reference planes.

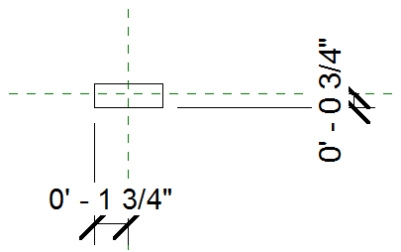

The orientation of the rectangle is important for the stud to appear properly in the wall.

Use the Pin tool and dimension tools as needed to constrain the profile.

6.  Select the **Types** tool.

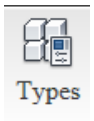

7. Select **New** under Family Types.

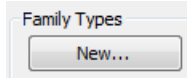

8. Enter **Stud 2" x 4"** in the Name field.

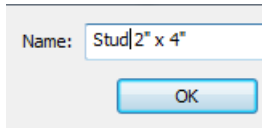

Press **OK**.

9. Press **OK** to close the dialog.

10.  Select **Save**.

11. Save the file as **Stud**.

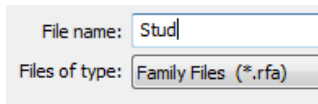

Close the file.

12. Open *ex3-4.rvt*.

13. Select one of the walls.

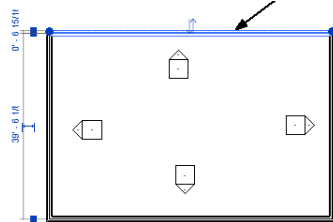

14. Select **Type Properties**.

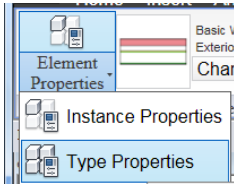

15. Select **Generic- 8"- Filled** under the Type list.

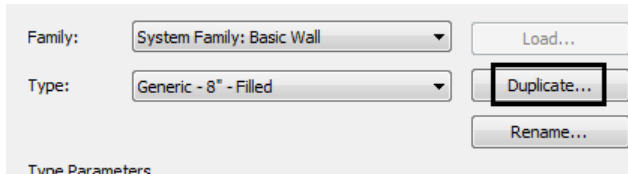

Select **Duplicate**.

16. Enter **Stud Wall** in the name field.

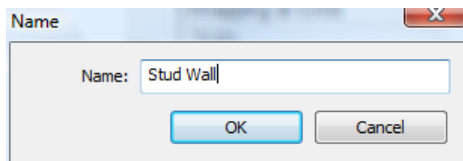

Press **OK**.

17. Select **Edit** next to Structure.

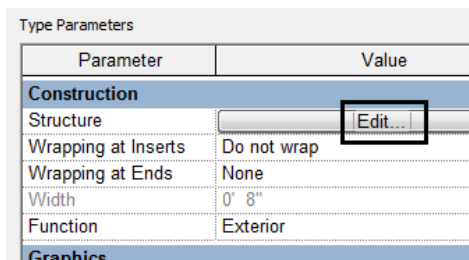

18.

	Function	Material	Thickness
1	Finish 1 [4]	Siding - Clapboard	0' 0 1/2"
2	Core Boundar	Layers Above Wrap	0' 0"
3	Substrate [2]	Wood - Sheathing - plywo	0' 0 1/2"
4	Thermal/Air L	Air Barrier - Air Infiltration	0' 3 1/2"
5	Core Boundar	Layers Below Wrap	0' 0"
6	Finish 2 [5]	Gypsum Wall Board	0' 0 1/2"

Create the following layer structure:

Layer 1: Finish 1 [4] Siding Clapboard 1/2"

Layer 2: Core Boundary

Layer 3: Substrate [2] Wood – Sheathing – Plywood 1/2"

Layer 4: Thermal/Air Layer Air Barrier- Air Infiltration 3 1/2"

Layer 5: Core Boundary

Layer 6: Gypsum Wall Board 1/2"

19.

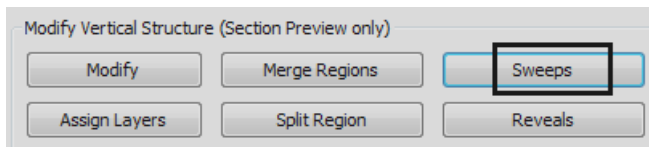

Select the **Sweeps** button.

20.



Select **Load Profile**.

21.

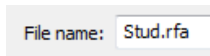

Locate the *Stud.rfa* profile you created.

22.

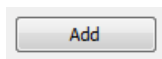

Select **Add**.

23.

	Profile	Material	Distance	From	Side	C
1	Default	<By Cat	0' 0"	Ba	Ext	0
	Sill-Precast : 12" Wide					
	Sill-Precast : 5" Wide					
	Sill-Precast : 8" Wide					
	Stud : Stud 2" x 4"					
	Wall Sweep-Brick Soldier Course : 1 Brick					
	Wall Sweep-Brick Soldier Course : 2 Bricks					

Locate the Stud profile that was loaded.

24.



We want to locate the stud profile so it is between the gypsum board and the plywood sheath.

25.

Wall Sweeps							
	Material	Distance	From	Side	Offset	Flip	Setback
1	Wood - Stud Layer	-0' 0 3/4"	Top	Interior	-0' 2 1/4"	<input type="checkbox"/>	0' 0"
2	Wood - Stud Layer	0' 0 3/4"	Base	Interior	-0' 2 1/4"	<input type="checkbox"/>	0' 0"

To have the profile placed properly:

Set the first Wall Sweep at a distance of $-3/4"$ from the Top.
 Offset it $-2 1/4"$ from the interior side.
 Set the second Wall Sweep at a distance of $3/4"$ from the Base.
 Offset it $-2 1/4"$ from the interior side.
 Press **OK**.

26. Press **OK** to close the dialog.

27.  Switch to a 3D view.

28. Determine which wall is the stud wall.
 If you select the wall, you will see the wall type displayed in the ribbon.

Basic Wall
Stud Wall

29. Select **Wall** → **Wall Sweep** from the Home ribbon.

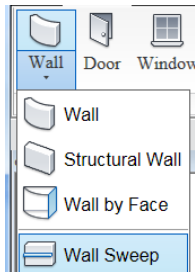

30. Select **Stud** from the drop-down.

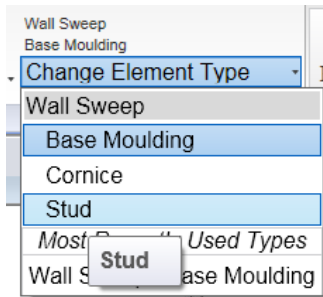

31.  Select Vertical orientation.

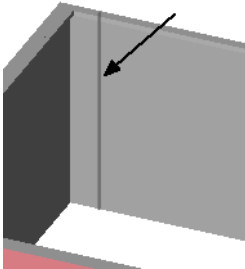
32.  Place the stud on the wall.
 Select **Finish Current**.
 Cancel out of the command.

33. Switch to **Level 1** floor plan for a plan view.

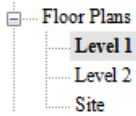

34. Use the **Move** tool to position the stud inside the wall.
Adjust the distance so the stud is located 16" from the wall end.

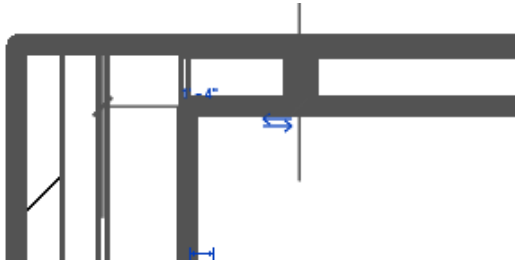

35. Select the wall stud.
Select the **Array** tool.



36. Set the center to center distance between the studs to 1' 4".

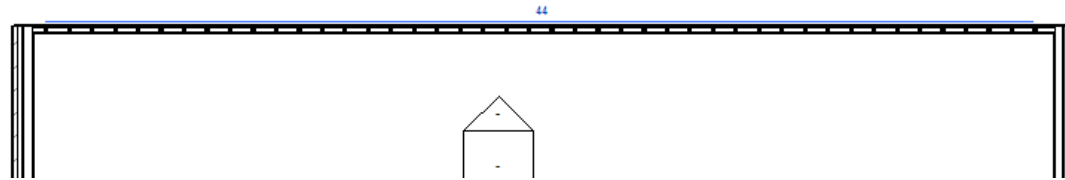
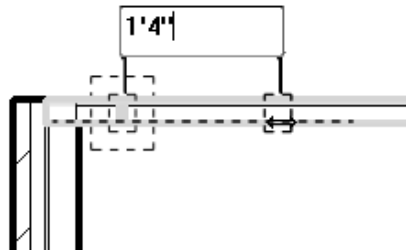

37. Set the number of studs to 44.

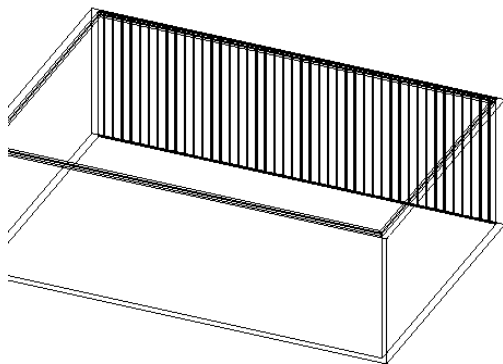

Switch to a 3D view.

Set it to wireframe.

You see a stud-framed wall.

38. Save as *ex2-5.rvt*.

Command Exercise

Exercise 2-6 – Chained Walls

Drawing Name: **i-walls.rvt**

Estimated Time to Completion: 10 Minutes

Scope

Using the Chain tool to create and select walls.

Solution

1.  Open *i-walls.rvt*.

2.  Select the **Wall** tool from the Home ribbon.

3.  Select the **Brick and CMU on MTL. Stud** wall style.

4.  Enable **Chain**.

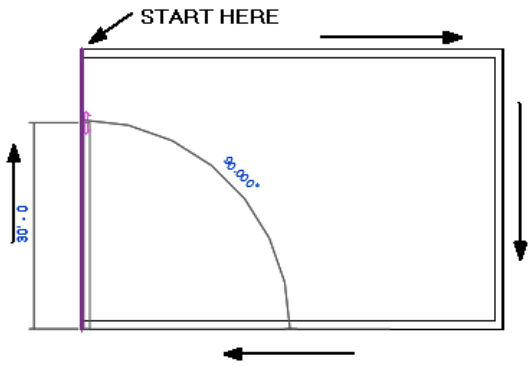
5.  Select the upper left vertex of the rectangle and draw the walls to place following the direction of the arrows.

Right click to cancel or press ESC to finish placing walls.

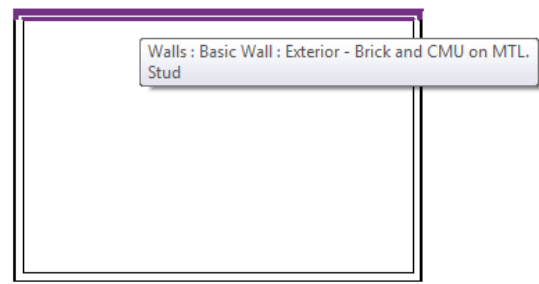
6.  Place the mouse over one of the walls so it highlights. **DO NOT SELECT.**

Press the TAB key.

All the walls highlight.

Left pick to select all four walls.

The Chain command constrains the walls together.

7.



Press the CONTROL key and drag the walls to the right.



The CONTROL key is used to create copies of selected elements.

8.

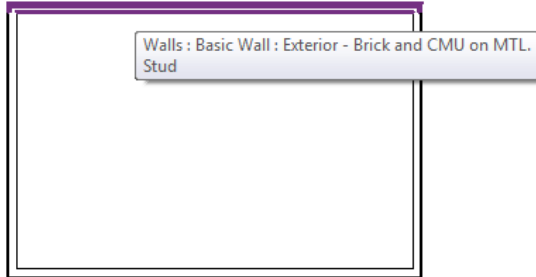

Place the mouse over one of the walls so it highlights. DO NOT SELECT.

Press the TAB key.
All the walls highlight.
Left pick to select all four walls.

The Chain command constrains the walls together.

9. Press the SHIFT key to move the selected walls.

10. Close the file without saving.

Practice Associate Exam

1. Which of the following can NOT be defined prior to placing a wall?

- A. Unconnected Height
- B. Base Constraint
- C. Location Line
- D. Profile
- E. Top Offset

2. Identify the compound wall.

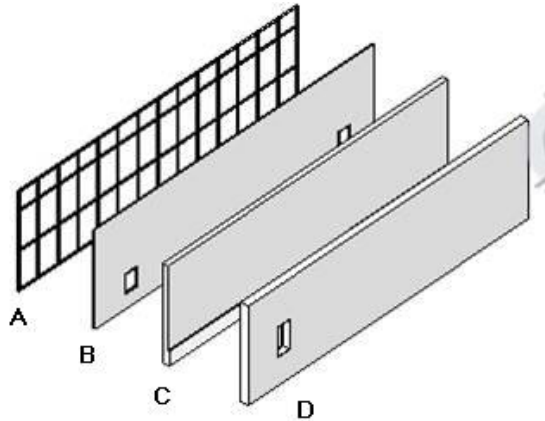

3. Walls are system families. Which name is NOT a wall family?

- A. BASIC
- B. COMPOUND
- C. CURTAIN
- D. COMPLICATED

4. Select the TWO which are wall properties:

- A. COARSE FILL PATTERN
- B. LOCATION LINE
- C. TOP CONSTRAINT
- D. FUNCTION
- E. BASE CONSTRAINT

5. Select ONE item that is used when defining a compound wall:

- A. MATERIAL
- B. SWEEPS
- C. GRIDS
- D. LAYERS
- E. FILL PATTERN

6. Enabling the Chain command when placing walls does the following:
 - A. Creates a daisy chain of walls.
 - B. Constrains the walls together so they can be moved and copied as a set.
 - C. Reduces the number of clicks required when placing walls.
 - D. Places a compound wall.

Answers:

1) D; 2) C; 3) D; 4) A & D; 5) B; 6) B