

Autodesk AutoCAD 2009: Fundamentals

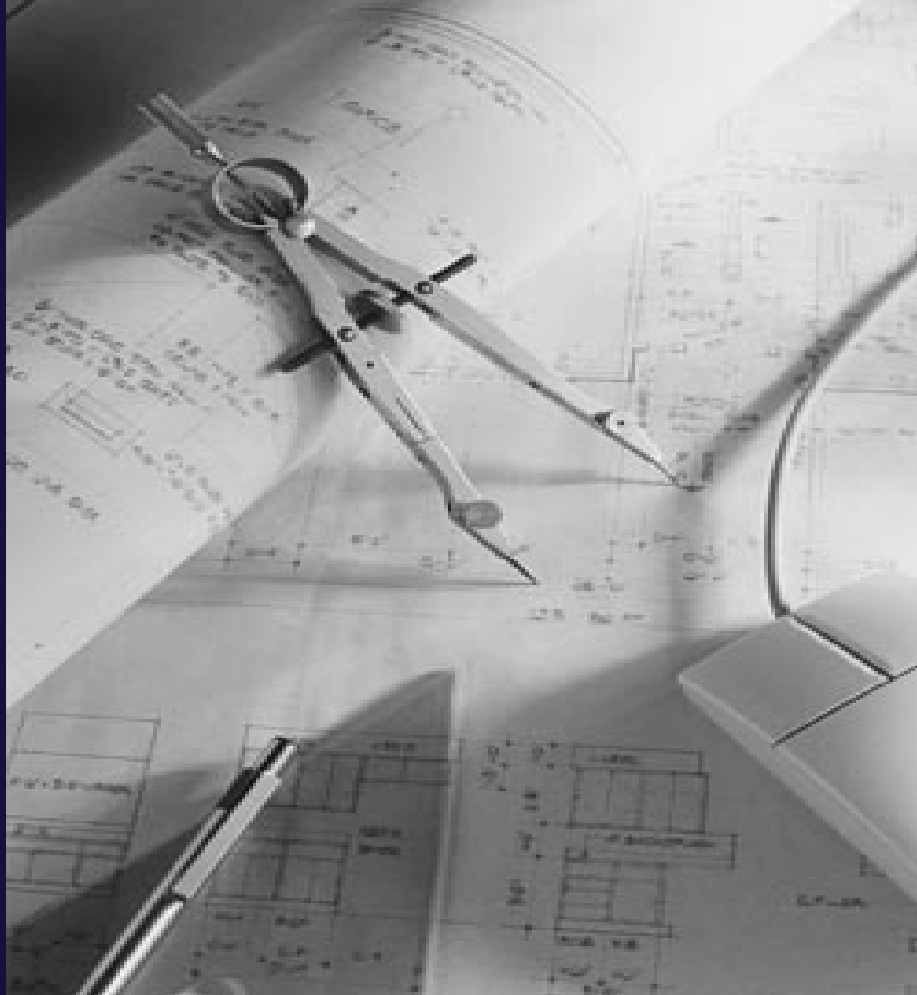

Elise Moss

autodesk[®]
authorized publisher

SDC
PUBLICATIONS

Schroff Development Corporation

www.schroff.com
www.schroff-europe.com

Lesson 3.0 – Drawing Lines

Estimated Class Time: 2 Hours

Objectives

This section introduces AutoCAD commands, for creating a simple drawing. Starting with a New drawing, the user will learn to draw lines using different methods.

- **Start From Scratch**
Use the New command to begin a new drawing from “scratch”.
- **Line**
Draw line segments.
- **Line**
Using Direct Distance Method
- **Line**
Using Polar Tracking
- **Line**
Using Cartesian Coordinates
- **Line**
Absolute Coordinates
- **Line**
Relative Coordinates
- **Line**
Polar Coordinates
- **Line**
Drag Method
- **Erase**
Deleting AutoCAD entities

Start from Scratch

Command Locator



| | |
|--------------------------|---------------------|
| <i>Toolbar Menu</i> | Standard/New |
| <i>Pull Down Menu</i> | File / New |
| <i>Command</i> | New |
| <i>Alias</i> | Ctrl+N |
| <i>RMB Shortcut Menu</i> | |

For the exercises in this section, we will be using the *Aec Model (Metric Ctb).dwt* template. This template setting was made when AutoCAD was installed. If you want to set a different default template to be used, go to the Options dialog and select the default template you wish to use.

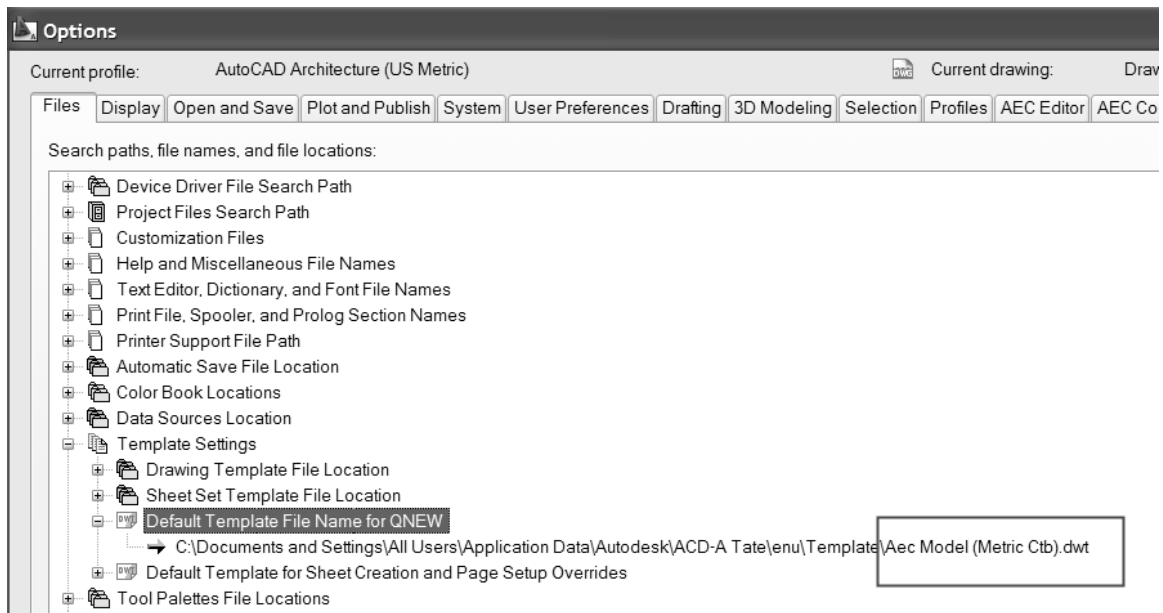

Figure 1 – The Options Dialog

Command Overview

To Create a New drawing, choose New. Every time the New drawing command is invoked, a new drawing is created with the title Drawing1, Drawing2, Drawing3, etc.

General Procedures

1. Select the New button from the Standard Toolbar



- Make it a habit to select the New file icon from the Standard Toolbar. This is a quicker way to access the command, then from the Pull-Down menu.
- Close drawings that are not being used.

| | |
|--|---|
| | <p>The graphics window uses a Cartesian coordinate system. The lower left corner of the screen shows a UCS (user coordinate system) icon. The icon shows x for horizontal and y for vertical. The z-axis is pointed toward the user. The UCS is located at the 0,0 or origin point.</p> |
|--|---|



At the lower left corner of your screen, you will see some numbers. These numbers reflect the coordinate point (x, y) of your mouse. Move your mouse around and note how the coordinate values change.

Tip
Use F6 to toggle your coordinates ON and off.



Your graphics window in AutoCAD emulates a piece of paper. LIMITS controls the size of your piece of paper. When you start a new file, you can specify the size of paper you want to draw on using Wizards or Templates. AutoCAD really doesn't care where you draw in your graphics window. You can draw outside the limits with impunity.

AutoCAD allows you to draw geometry using four methods:

- Absolute Coordinates
- Relative Coordinates
- Polar Coordinates
- Direct Entry

Absolute Coordinates use absolute values relative to the origin.

Relative Coordinates use coordinates relative to the last point selected.

Polar Coordinates use a distance and angle relative to the last point selected.

Direct Entry allows the user to set ORTHO on (this is like using a ruler to draw a straight line), move the mouse in the desired direction, and then enter in the desired distance.

Line

Command Locator



| | |
|-----------------------|------------------|
| <i>Toolbar Menu</i> | Draw/Line |
| <i>Pull Down Menu</i> | Draw/Line |
| <i>Command</i> | Line |
| <i>Alias</i> | L |

Command Overview

A line is defined by two endpoints. A line has 0 width and 0 thickness. When drawing a line, specify the first point, then specify the next point. Press the enter button on the mouse (with the cursor in the drawing window) to access the Line Shortcut menu. Type C to close two or more line segments.

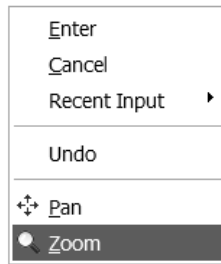

Figure 2 – Line Shortcut Menu

| Line Short-Cut Menu Option: | Overview |
|-----------------------------|---|
| Enter | Select to exit the Line command. |
| Cancel | Cancels the command. |
| Recent Input | Lists the most recently entered point coordinates |
| Close | Closes the line to form a closed polygon. |
| Undo | Undoes the last segment of the line. |
| Pan | Begins Real-Time Pan |
| Zoom | Begins Real-Time Zoom |

General Procedures

1. Begin the line command by selecting the line icon in the Draw Toolbar or typing L at the blank command prompt.
2. Select the first point, select the next point, and continue selecting the endpoints of each successive line segment.
3. Press the <ENTER> button on the mouse (with the cursor in the drawing window), then select <ENTER> to end the Line command.
4. Press <ENTER> to Repeat the Line command.



- Move the mouse after selecting each endpoint of the line. This will make it easier to see the last line segment created.
- Double click on ORTHO in the Status Bar (or press F8) to alternate between drawing straight or angled line segments.
- Typing U for Undo in the middle of the line command will undo the last line segment. Typing U after completing line segments (at the blank command prompt) will Undo the entire line command.

Command Exercise

Exercise 3-1 – Line using Direct Distance Method

Drawing Name: **Begin a new drawing**

Estimated Time to Completion: 10 Minutes

Scope

Start a New drawing using the acad.dwt template. Enable DYN. With ORTHO on, draw the object below. Drag the line in the desired direction and type the distance. Do not add the dimensions.

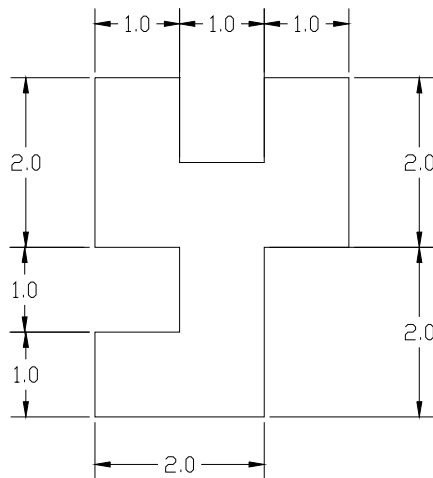

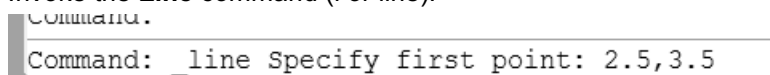

Figure 3 – Line Exercise

Solution

1. Turn **ORTHO** on by pressing <F8> until the command line says '<Ortho on>'.

2. Invoke the **Line** command (l or line).



```
Command:
Command: line Specify first point: 2.5,3.5
```

3. Specify next point or [Undo]:
Type **2.5** for the X-coordinate. Type **3.5** for the Y-coordinate. Press **ENTER**.

4.

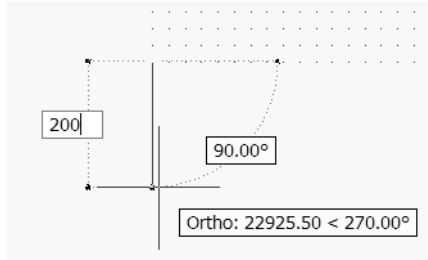

Specify next point or [Undo]:
 Drag the cursor downward and type **200** and press <ENTER>.

5.

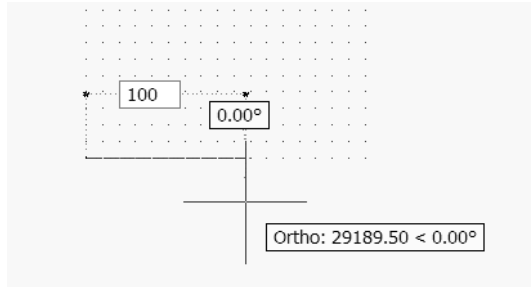

Specify next point or [Undo]:
 Drag the cursor to the right and type **100** and press <ENTER>.

6.

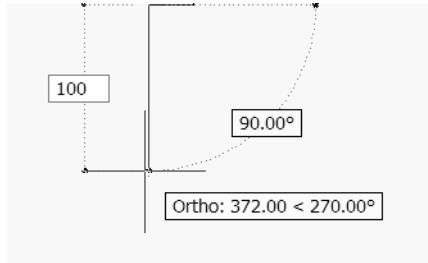

Specify next point or [Close/Undo]:
 Drag the cursor downward and type **100** and press <ENTER>.

7.

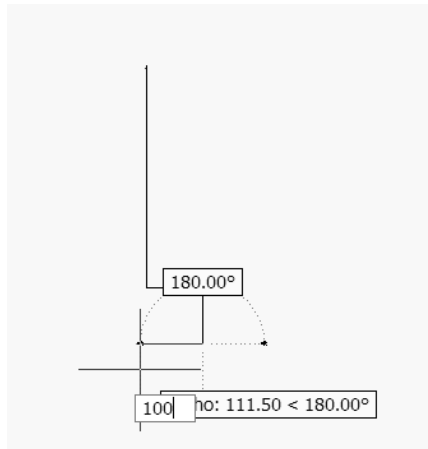

Specify next point or [Close/Undo]:
 Drag the cursor to the right and type **100** and press <ENTER>.

8.

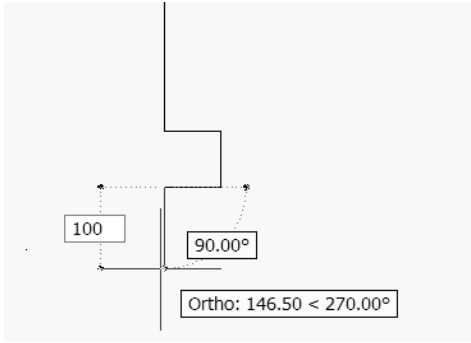

Specify next point or [Close/Undo]:
 Drag the cursor downward and type **100** and press <ENTER>.

9.

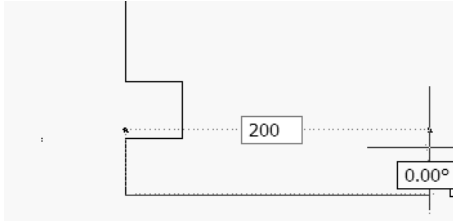

Specify next point or [Close/Undo]:
 Drag the cursor to the right and type **200** and press <ENTER>.

10.

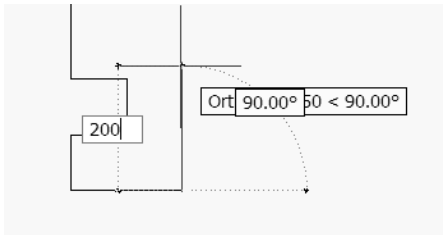

Specify next point or [Close/Undo]:
 Drag the cursor up and type **200** and press <ENTER>.

11.

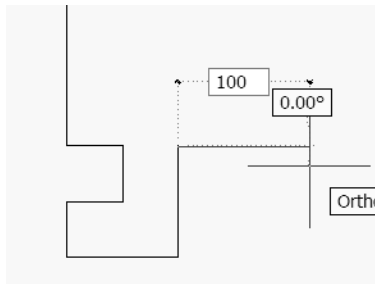

Specify next point or [Close/Undo]:
 Drag the cursor to the right and type **100** and press <ENTER>.

12.

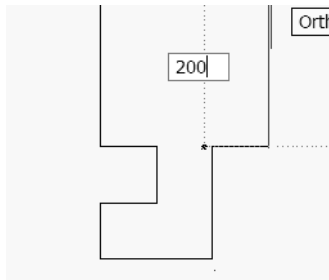

Specify next point or [Close/ Undo]:
 Drag the cursor upward and type **200** and press <ENTER>.

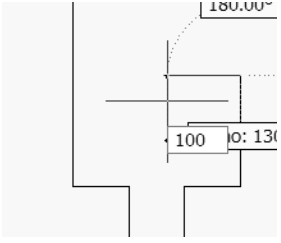
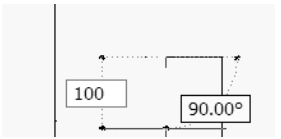
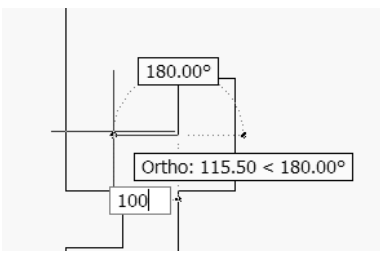
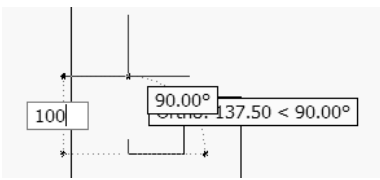
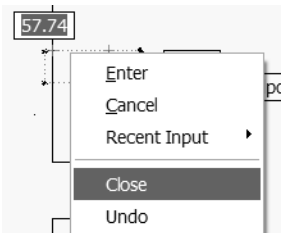
13.  *Specify next point or [Close/Undo]:*
 Drag the cursor to the right and type **100** and press <ENTER>.
14.  *Specify next point or [Close/Undo]:*
 Drag the cursor downward and type **100** and press <ENTER>.
15.  *Specify next point or [Close/Undo]:*
 Drag the cursor to the left and type **100** and press <ENTER>.
16.  *Specify next point or [Close/Undo]:*
 Drag the cursor upward and type **100** and press <ENTER>.
17.  *Specify next point or [Close/Undo]:*
 Right-click in the drawing area and select 'Close' or type 'C' and press <ENTER>.

Tip
 If the lines look crooked, then ORTHO is not on. You must begin again. Try to draw all of the line segments without starting and stopping the line command.

The **Close** option only works if you draw in one continuous line. Otherwise, you can simply draw a closing line from endpoint to endpoint.

Command Exercise

Exercise 3-2 – Line Using Polar Tracking

Drawing Name: **Line2.dwg**

Estimated Time to Completion: 10 Minutes

Scope

Open 'line2.dwg' and draw the object shown in the example using the line command with POLAR enabled. Polar settings have already been made to create the necessary angles. When you have completed the third segment, type C to close the object. Press <ENTER> to repeat the line command, press <ENTER> again, and see that the line picks up from the last point selected.



Figure 4 – Line Exercise

Solution

1. Turn **POLAR** on.

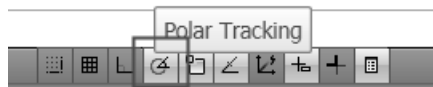

Invoke the **Line** command (l or line).

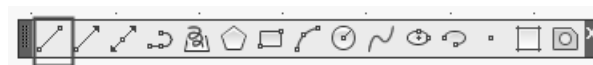

2. *Specify first point:*
Pick a start point of the line with your left mouse button near the #1 on the drawing.

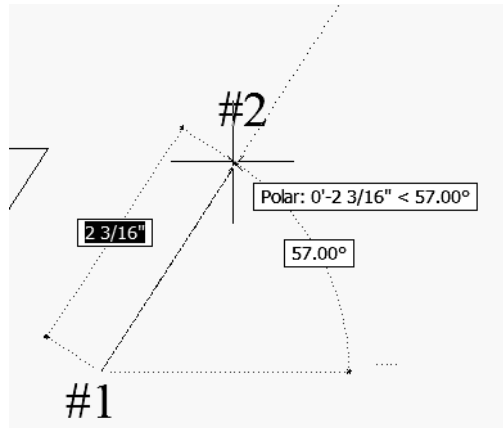

3. *Specify next point or [Undo]:*
 Pick a second point near the #2 on the drawing.
 As you draw your line up to the #2, look for the Tooltip indicating the 57-degree angle.

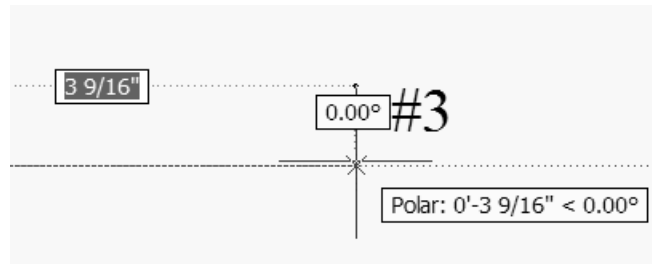

4. *Specify next point or [Undo]:*
 Move your mouse near #3 and click to complete the second line segment.
 As you draw your line up to the #2, look for the Tooltip indicating the 0-degree angle.

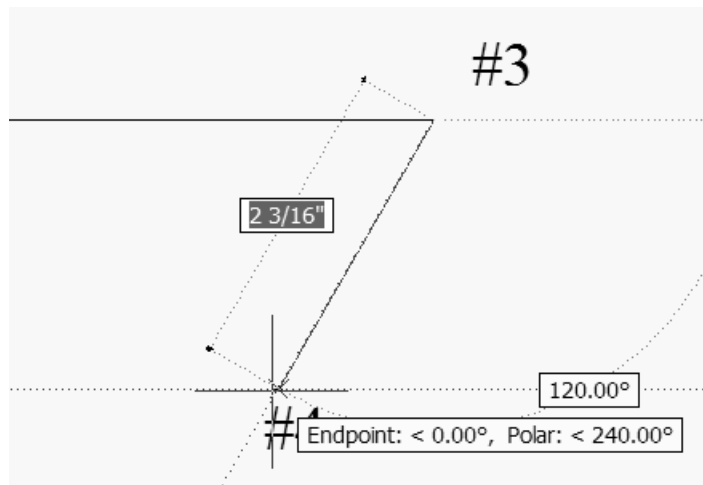

5. *Specify next point or [Close/Undo]:*
 Use Object Tracking to line up your end point and set the Polar Angle to 240-degrees.

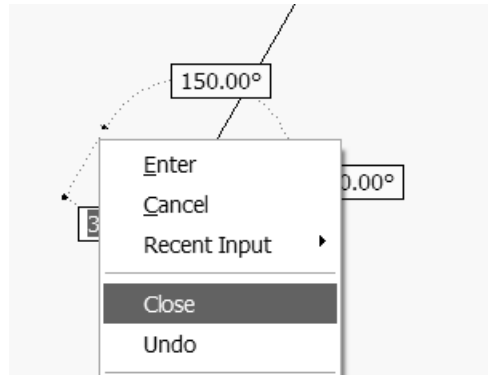

6. *Specify next point or [Close/Undo]:*
Right-click in the drawing area and select **Close** or type 'C' or 'CLOSE' and press <ENTER> at the command line to create the final line segment.
7. Right-click in the drawing area and select **Repeat Line** or press <ENTER> to repeat the line command.
8. *Specify first point:*
Press <ENTER> to start the line at the last point selected.
9. *Specify next point or [Undo]:*
Press <Esc> to clear the command line.

Tips

When you closed your object did it complete the parallelogram? If not, you may have stopped and restarted the line sequence, in which case the close option will refer to the new start point.

Move your mouse, as you work to see what line segments you have just completed. Click on ORTHO in the Status bar, or press the <F8> function key. Whichever is more convenient at the time.

Make a habit of using the <ENTER> key to complete your AutoCAD commands, and to repeat the last command used. Alternately, you may click the right mouse button and select the Repeat option.

In order for Polar Tracking to click to specific angle values, you have to have them set. Use Settings in the Polar Tracking dialog to add angles you want to use in your drafting.

Command Exercise

Exercise 3-3 – Line Using Cartesian Coordinates

Drawing Name: **Begin a new drawing**

Estimated Time to Completion: 10 Minutes

Scope

Start a New Drawing using the acad.dwt template and draw the object shown in the example using the line command with Cartesian Coordinates. When you have completed the third segment, type C to close the object. Press <ENTER> to repeat the line command, press <ENTER> again, and see that the line picks up from the last point selected. Turn DYN off and ORTHO on for this exercise.

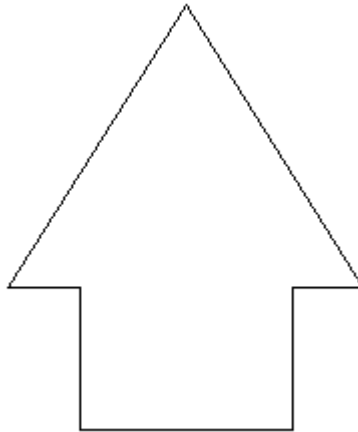
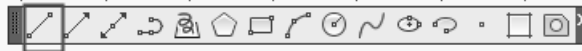

Figure 5 – Line Exercise

Solution

1. Invoke the **Line** command (l or line).



2. *Specify first point:*
Type **0,0** at the command line.
3. *Specify next point or [Undo]:*
Type **3,0**.
4. *Specify next point or [Undo]:*
3,2
5. *Specify next point or [Close/Undo]:*
4,2
6. *Specify next point or [Close/Undo]:*
1.5,6

7. Specify next point or [Close/Undo]:
-1,2
8. Specify next point or [Close/Undo]:
0,2
9. Specify next point or [Close/Undo]:
Right-click in the drawing area and select 'Close' or type 'C' or 'CLOSE' and press <ENTER> at the command line to create the final line segment.

Tip

If your drawing did not turn out properly, make sure you had DYN OFF. To check your data entry, press F2 and the text window will open and you can review your entries.

Coordinate Entry

Command Locator

| | |
|--------------------------|-------------------------|
| <i>Toolbar Menu</i> | |
| <i>Pull Down Menu</i> | |
| <i>Command</i> | Type coordinates |
| <i>Alias</i> | |
| <i>RMB Shortcut Menu</i> | |
| <i>Dialog Box</i> | |

Command Overview

Once the Units have been established, coordinates can be typed to specify points or distances. Always draw full scale. There are four ways to specify coordinates: absolute, relative, polar, and direct distance.

| <i>Coordinate Entry Method</i> | <i>Overview</i> | <i>Examples</i> |
|--------------------------------|--|--------------------------|
| Absolute Coordinates | The x and y coordinates are determined by an absolute Origin point of 0,0. | X,Y 1,5 |
| Relative Coordinates | The x and y coordinates reference the last point selected in the drawing. | @x,y @3,5 |
| Polar Coordinates | The distance and angle specified references the last point selected in the drawing | @distance<angle @5<45 |
| Direct Distance | Select the first point, then drag the cursor in the desired direction and type the distance. | Type the distance 4 |

General Procedures

Using Absolute Coordinates:

1. When prompted to specify a point, type the Absolute coordinates for x and y (x,y)
2. Type the Absolute Coordinate for each successive point (x,y).

Typical Example: Inserting a Title Block or an Externally Referenced Drawing at a specific location.

Using Relative Coordinates:

1. When prompted to specify a point, select a point in the drawing.
2. Type the Relative Coordinate for each successive point (@x,y).

Typical Example: Drawing a Rectangle.

Using Polar Coordinates:

1. When prompted to specify a point, select a point in the drawing.
2. Type the Polar Coordinate for each successive point (@distance < angle).

Typical Example: Drawing lines or moving objects at a specified distance and angle other than orthogonal angles.

Using Direct Distance:

1. When prompted to specify a point, select a point in the drawing.
2. Turn ORTHO on and drag the cursor in the desired direction.
3. Type the distance and press <ENTER>.

Typical Example: Drawing lines or using the Move, Copy or Stretch commands.



-
- Always use object snap for selecting specific points in the drawing.
 - Remember to separate the x and y coordinates by a comma.
Example: 1,5 means the absolute coordinate where x=1 and y=5.
 - It is not necessary to type the z coordinate when z = 0.
 - Angles are typically measured counter-clockwise. Angle 0 is typically East.
 - Precede Relative and Polar coordinate information with an @ sign (over the number 2 on the keyboard).
 - ORTHO should be on when using the direct distance method.
 - When drawing lines, or moving objects at specific angles (other than with ORTHO on), type the polar coordinate (example: @10<45) or use Polar Tracking Settings.
 - Typing the minimum number of keystrokes is important for drawing efficiently. AutoCAD will fill in leading and trailing zeros and the appropriate Unit endings.
 - AutoCAD will convert decimal equivalents to feet and inches.
 - AutoCAD will assume inches, unless the foot mark ' is typed.
 - The Coordinates Display can be turned on or off from the Status Bar by double clicking on it (LMB). If in the middle of a Draw or Modify command, a third option will display the distance and <angle.
 - The DYN toggle can be used to display and enter coordinates.
-

Command Exercise

Exercise 3-4 – Absolute Coordinates

Drawing Name: **entry1.dwg**

Estimated Time to Completion: 5 Minutes

Scope

Start the line command. Draw the objects using the absolute coordinates in the order indicated. Connect the points using only the keyboard. Turn DYN off and ORTHO on.

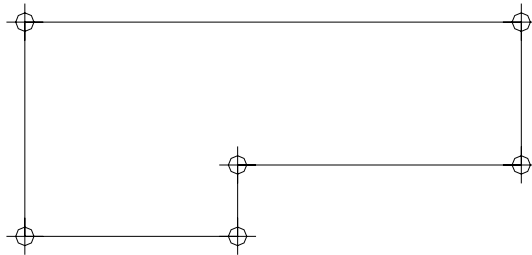
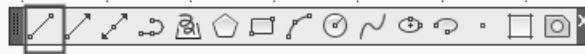

Figure 6 – Absolute Coordinates Exercise

Solution

1. Invoke the **Line** command (l or line).



2. *Specify first point:*
Type **1,1** at the command line and press <ENTER>. Notice where the first point of the line is created.
3. *Specify next point or [Undo]:*
Type **4,1** at the command line and press <ENTER>.
4. *Specify next point or [Undo]:*
Type **4,2** at the command line and press <ENTER>.
5. *Specify next point or [Close/Undo]:*
Type **8,2** and press <ENTER>.
6. *Specify next point or [Close/Undo]:*
Type **8,4** and press <ENTER>.
7. *Specify next point or [Close/Undo]:*
Type **1,4** and press <ENTER>.
8. *Specify next point or [Close/Undo]:*
Type **1,1** and press <ENTER>.
9. *Specify next point or [Close/Undo]:*
Press the <ENTER> key to end the command.

Tip

You can also use the close option to complete the exercise rather than typing in the final '1,1'.

Command Exercise

Exercise 3-5 – Relative Coordinates

Drawing Name: **entry2.dwg**

Estimated Time to Completion: 5 Minutes

Scope

Start the line command. Draw the objects using the relative coordinates in the order indicated. Connect the points using only the keyboard.

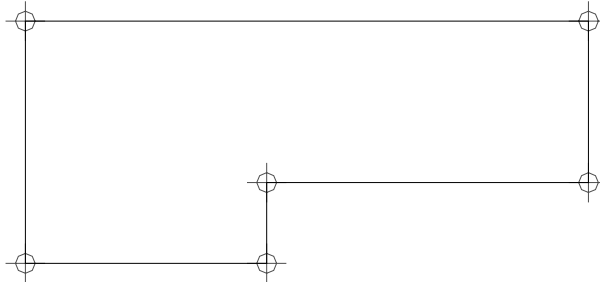

Figure 7 – Relative Coordinates Exercise

Solution

1. Invoke the **Line** command (l or line).



2. *Specify first point:*
Type **1,1** at the command line and press <ENTER>. Notice where the first point of the line is created.
3. *Specify next point or [Undo]:*
Type **@3,0** at the command line and press <ENTER>.
4. *Specify next point or [Undo]:*
Type **@0,1** at the command line and press <ENTER>.
5. *Specify next point or [Close/Undo]:*
Type **@4,0** and press <ENTER>.
6. *Specify next point or [Close/Undo]:*
Type **@0,2** and press <ENTER>.
7. *Specify next point or [Close/Undo]:*
Type **@-7,0** and press <ENTER>.
8. *Specify next point or [Close/Undo]:*
Type **@0,-3** and press <ENTER>.
9. *Specify next point or [Close/Undo]:*
Press the <ENTER> key to end the command.

Extra

What would you type in to create the shape in a clockwise fashion instead of counter clockwise direction? Try it.

Command Exercise

Exercise 3-6 – Polar Coordinates

Drawing Name: **entry3.dwg**

Estimated Time to Completion: 5 Minutes

Scope

Start the line command. Draw the objects using the polar coordinates in the order indicated. Connect the points using only the keyboard.

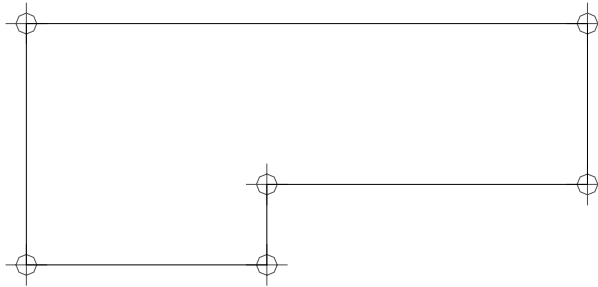

Figure 8 – Polar Coordinates Exercise

Solution

1. Invoke the **Line** command (l or line).



2. *Specify first point:*
Type **1,1** at the command line and press <ENTER>. Notice where the first point of the line is created.
3. *Specify next point or [Undo]:*
Type **@3<0** at the command line and press <ENTER>.
4. *Specify next point or [Undo]:*
Type **@1<90** and press <ENTER>.
5. *Specify next point or [Close/Undo]:*
Type **@4<0** and press <ENTER>.
6. *Specify next point or [Close/Undo]:*
Type **@2<90** and press <ENTER>.
7. *Specify next point or [Close/Undo]:*
Type **@7<180** and press <ENTER>.
8. *Specify next point or [Close/Undo]:*
Type **@3<270** and press <ENTER>.
9. *Specify next point or [Close/Undo]:*
Press the <ENTER> key to end the command.

Extra

What would happen if you typed **@-3<180** in step 3 in the exercise?

Try it.

Erase

Command Locator



| | |
|-----------------------|---------------------|
| <i>Toolbar Menu</i> | Modify/Erase |
| <i>Pull Down Menu</i> | Modify/Erase |
| <i>Command</i> | Erase |
| <i>Alias</i> | E |

Command Overview

Erase deletes selected objects. Press <ENTER> after selecting the objects to erase to execute the command. Type OOPS to bring back the last set of erased objects, even if other objects were drawn since the last erase.

General Procedures

1. Begin the erase command by selecting the Erase icon from the Modify Toolbar or typing E at the blank command prompt.
2. Place the cursor over the objects to erase and pick (LMB).



-
- If the cursor is not over an object, a selection window will appear. Make the other corner of the selection window.
 - A Selection Window made from Left to Right will select only the objects completely in the window.
 - A Selection Window made from Right to Left will select all objects the window crosses.
 - Typing All (and pressing <ENTER>) will select all objects in the drawing to erase. Press <ENTER> to execute the command.
-

Command Exercise

Exercise 3-8 – Erase

Drawing Name: **erase1.dwg**

Estimated Time to Completion: 5 Minutes

Scope

Erase the objects in the drawing. Draw some more lines. Type *OOPS* to bring back the last set of erased objects.

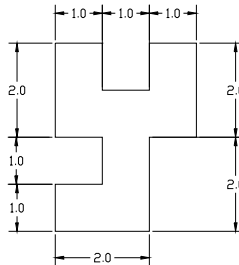
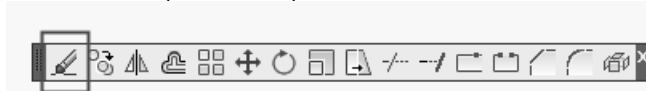

Figure 10 – Erase Exercise

Solution

1. Invoke the **Erase** command (e or erase).



2. *Select objects:*
Select the objects by typing **ALL** and pressing <ENTER>, picking each line individually, or using the Window method. When all the objects are highlighted, press <ENTER> to execute the Erase command.
3. Invoke the **Line** command (l or line).



4. *Specify first point:*
Use your LMB to pick the start point of a line segment. Select any location on the drawing.
5. *Specify next point or [Undo]:*
Continue to use the LMB to create lines on the drawing.
6. *Specify next point or [Close/Undo]:*
Press the <ENTER> key to end the line command.
7. Type **OOPS** at the command line and press the <ENTER> key.

Tip

Select all the objects to erase, then press <ENTER> to execute the command. To remove an object from the selection set, hold down the shift key and select the object again. See that it is removed from the selection set. Then press <ENTER>.

Review Questions

1. At the select object prompt, what letter must you type to select using a window?
 - W
 - SO
 - SP
 - S

2. Write down the letter to type for each of the following Object Selection options:
 - Previous _____
 - Last _____
 - Fence _____
 - All _____
 - Crossing Window _____
 - Crossing Polygon _____
 - Window Polygon _____

3. When selecting objects by picking in a blank area in the drawing window, what is the difference between the following:
 - Making a select box from right to left. _____
 - Making a select box from left to right. _____

4. When using the POLAR method of coordinate entry, which tray button should be enabled?

5. When entering direct coordinates, which tray button should be disabled?

Review Answers

1. W for window
2. P,L,F,A or enter, CW, CP, CW.
3. WINDOW, CROSSING
4. POLAR
5. DYN